

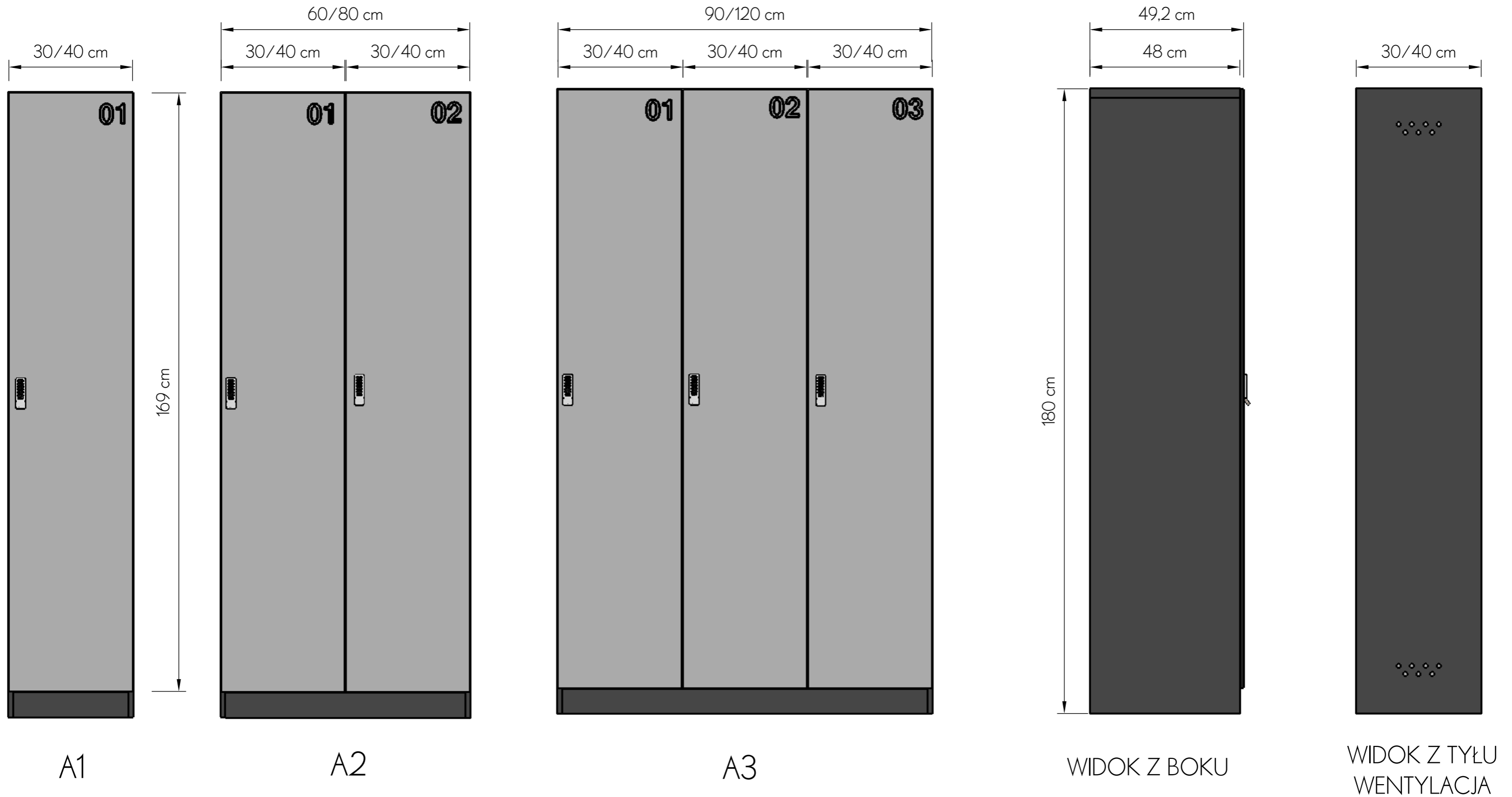

HEBE^{MT} HYBRID

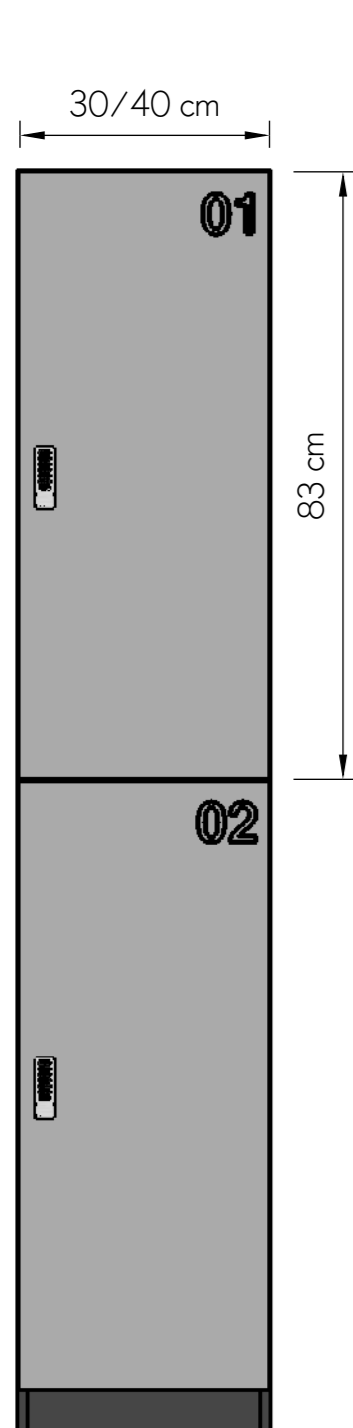





B2

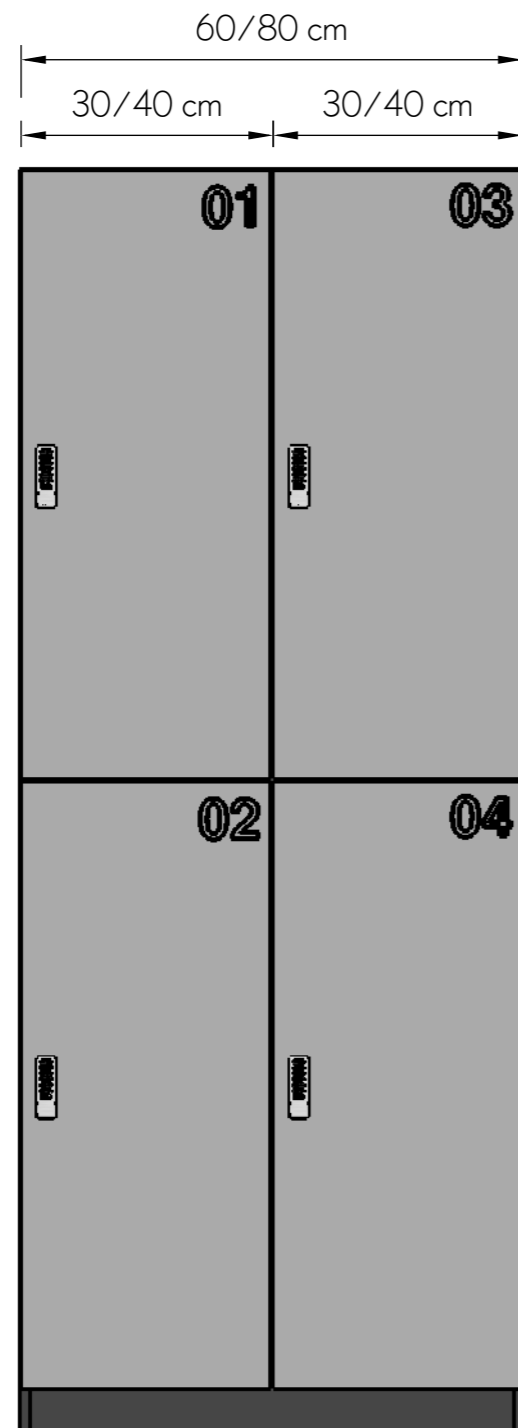

B4

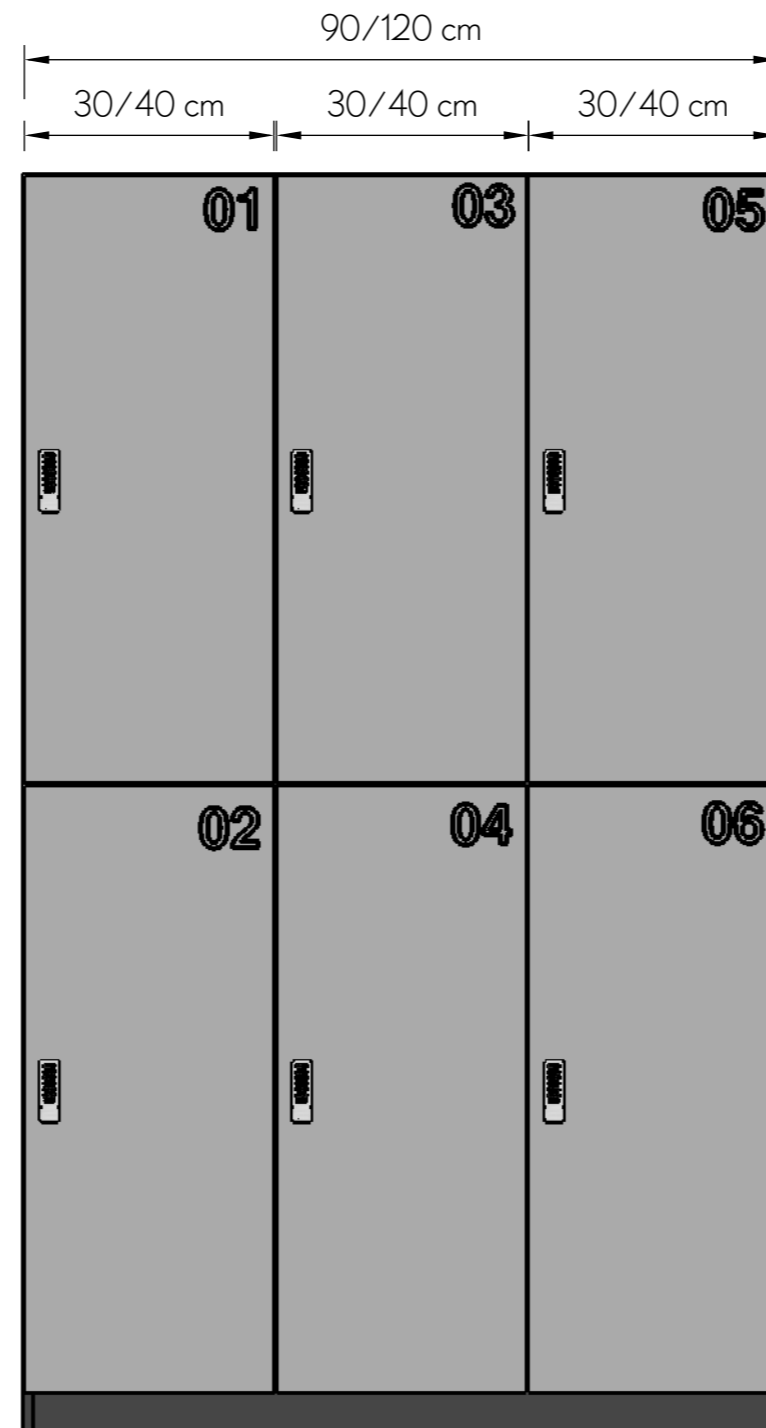

B6

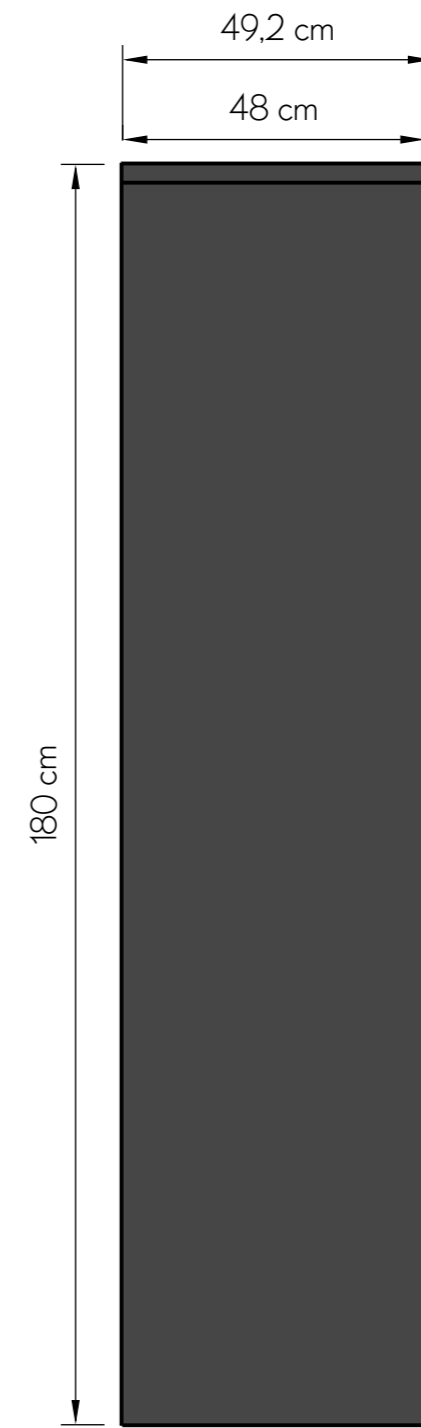

WIDOK Z BOKU

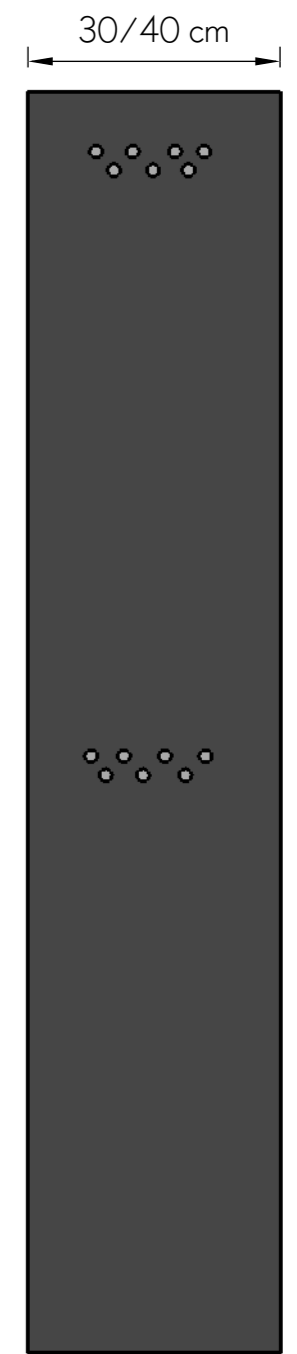

WIDOK Z TYŁU
WENTYLACJA

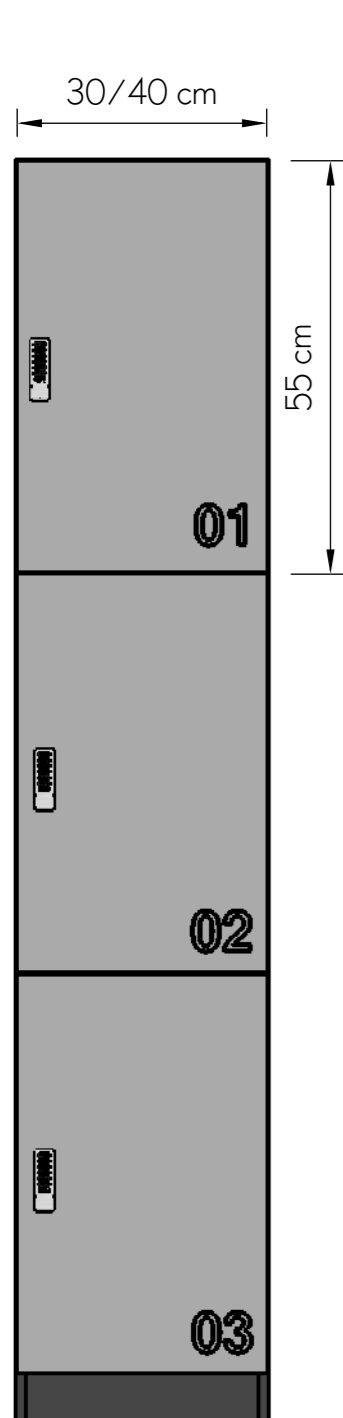

C3

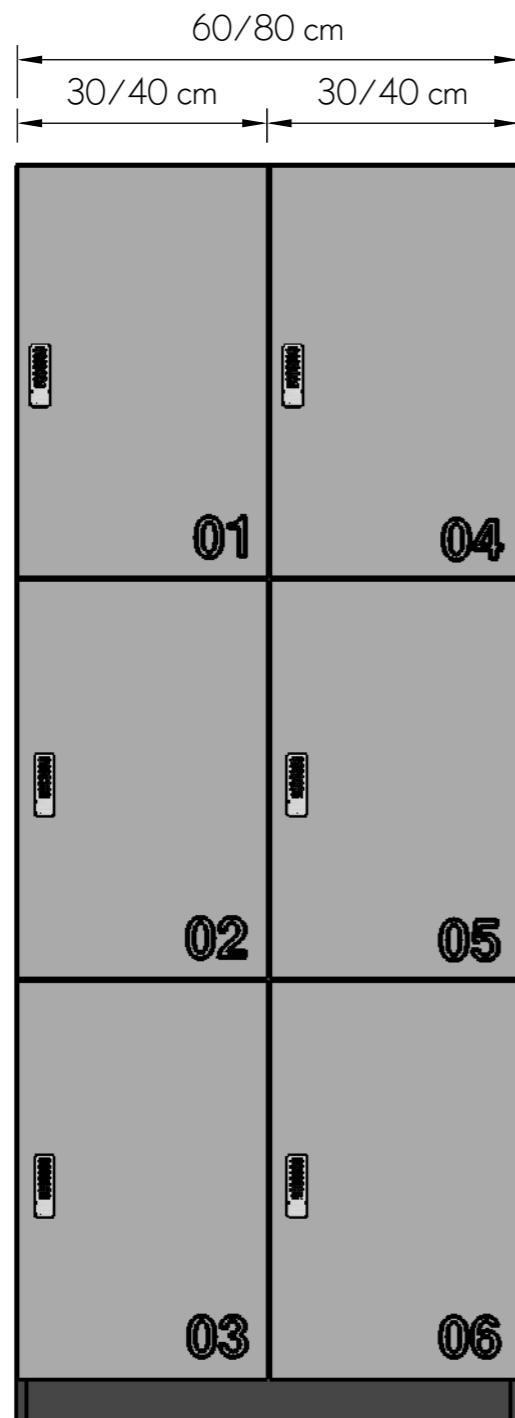

C6

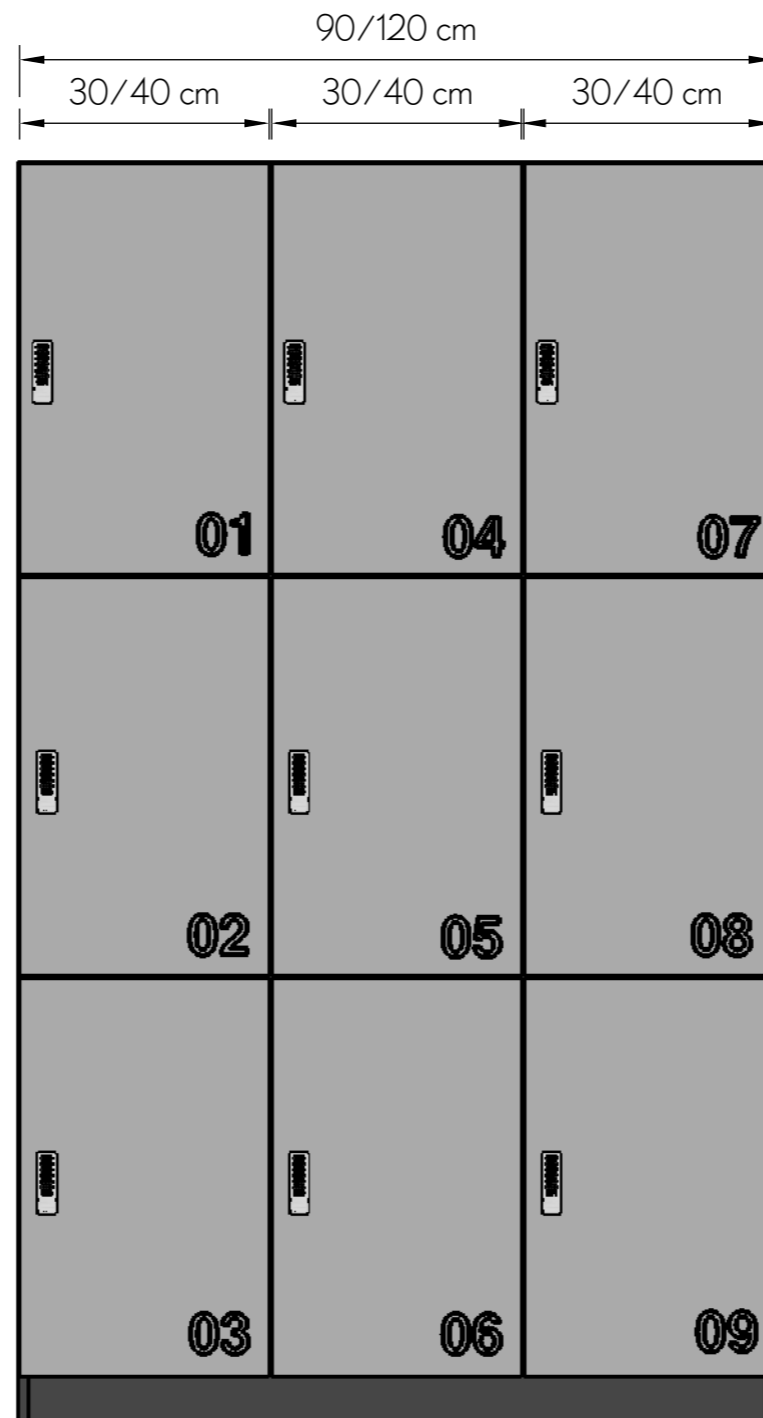

C9

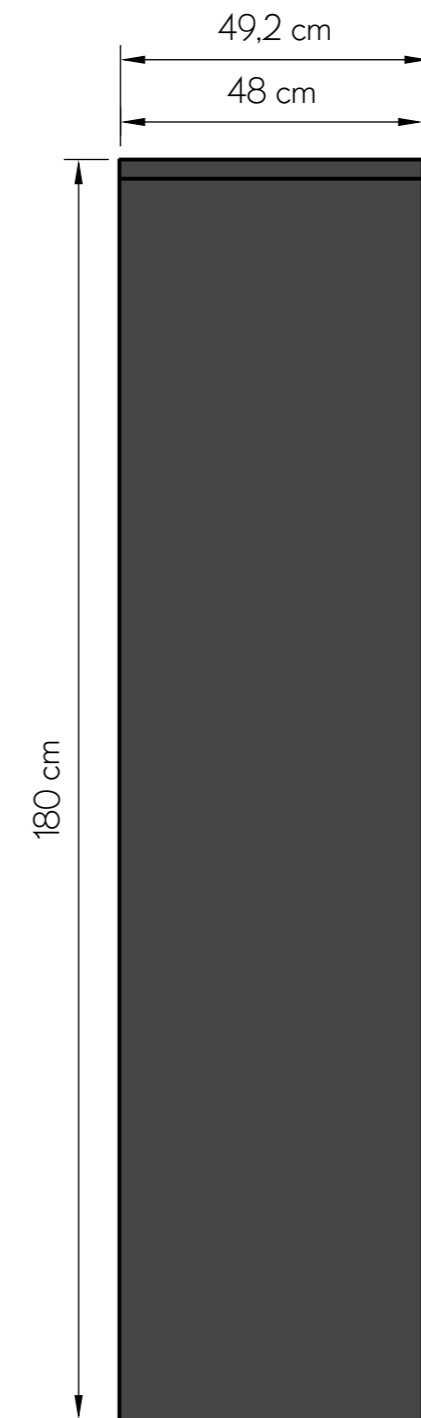

WIDOK Z BOKU

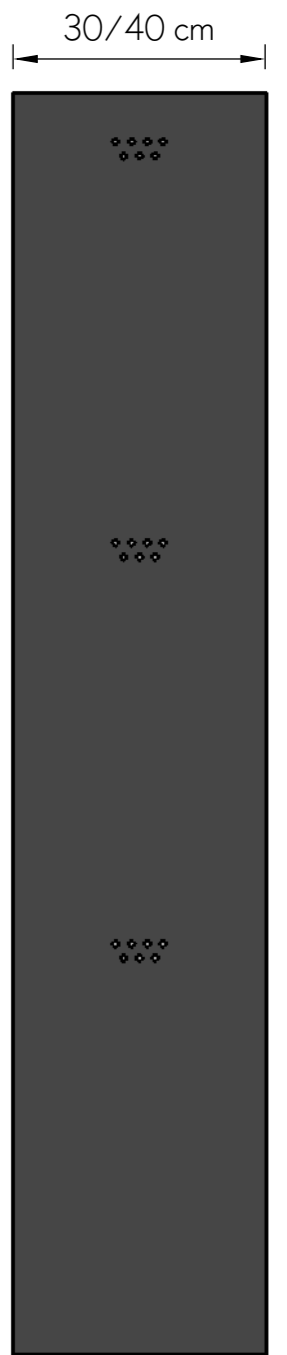

WIDOK Z TYŁU
WENTYLACJA

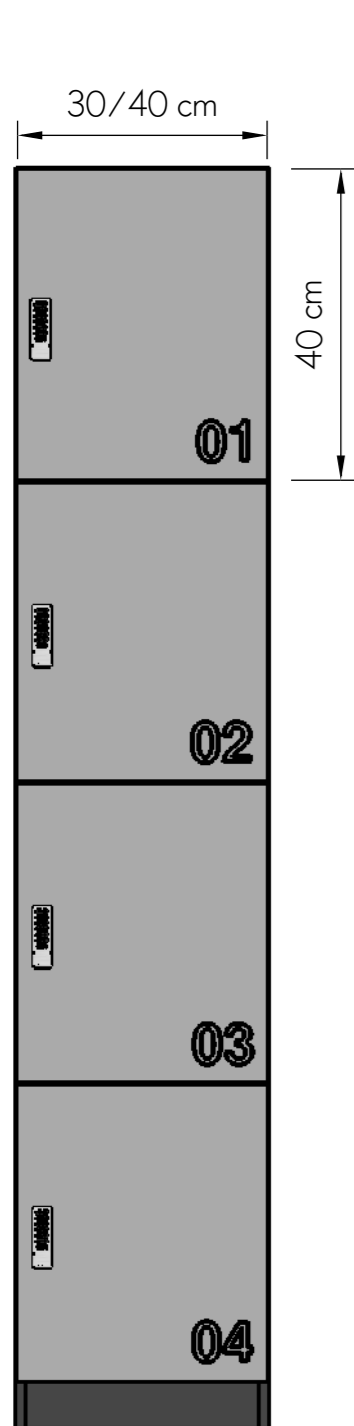

D4

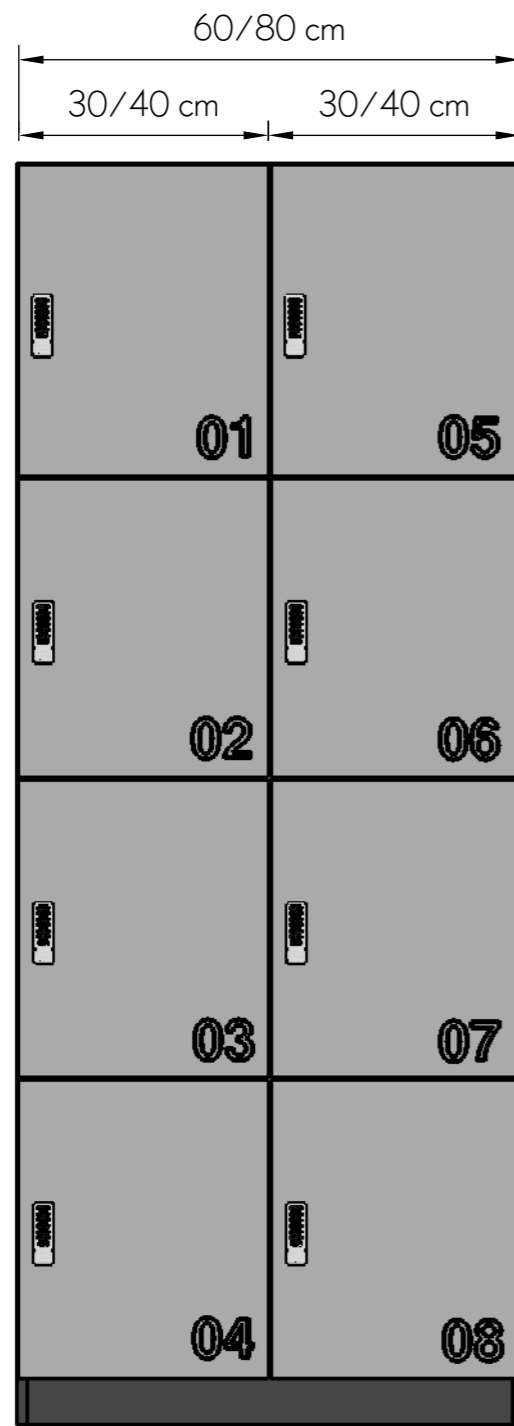

D8

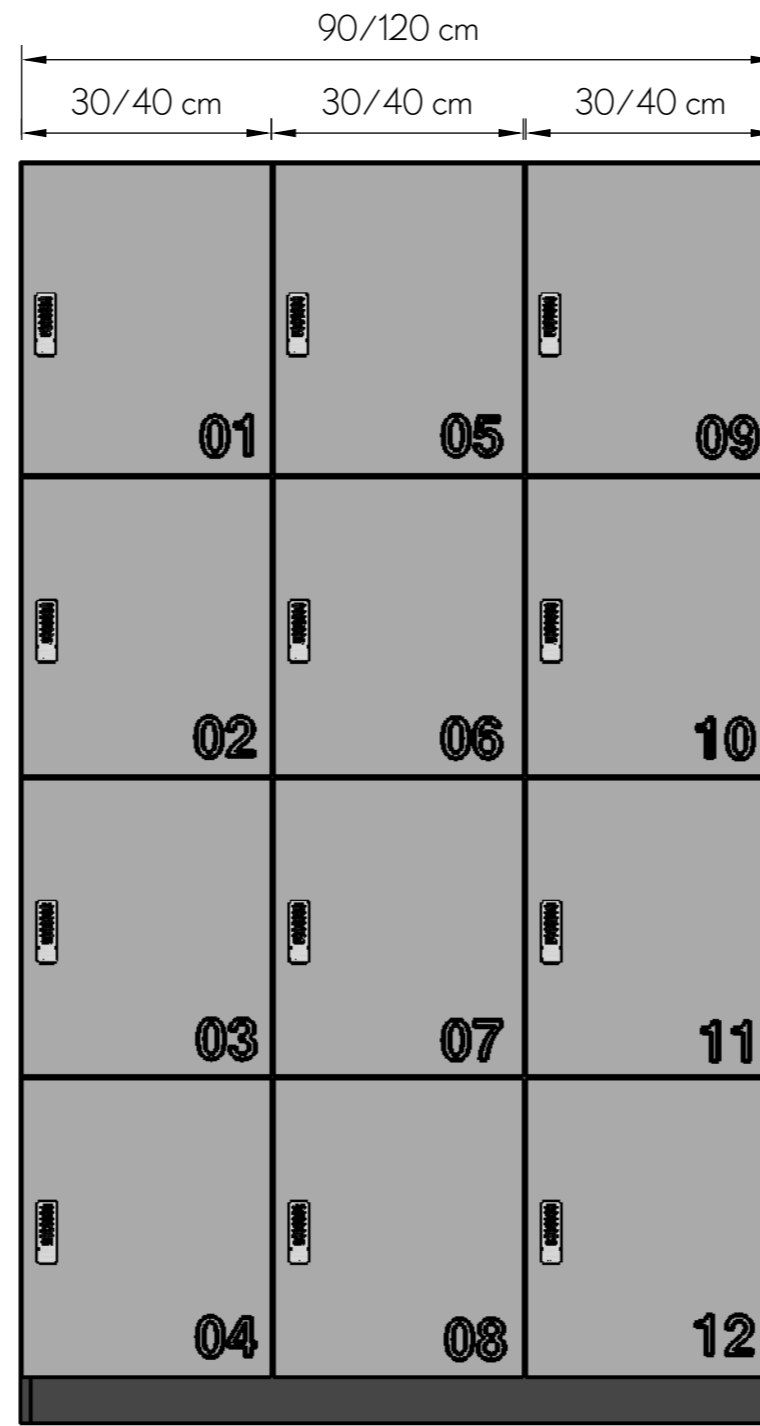

D12

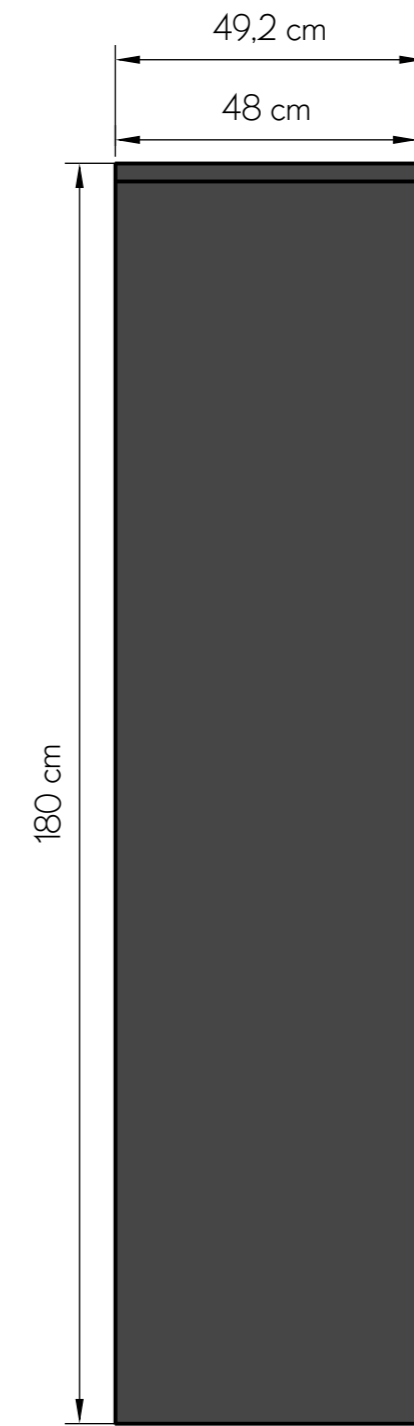

WIDOK Z BOKU

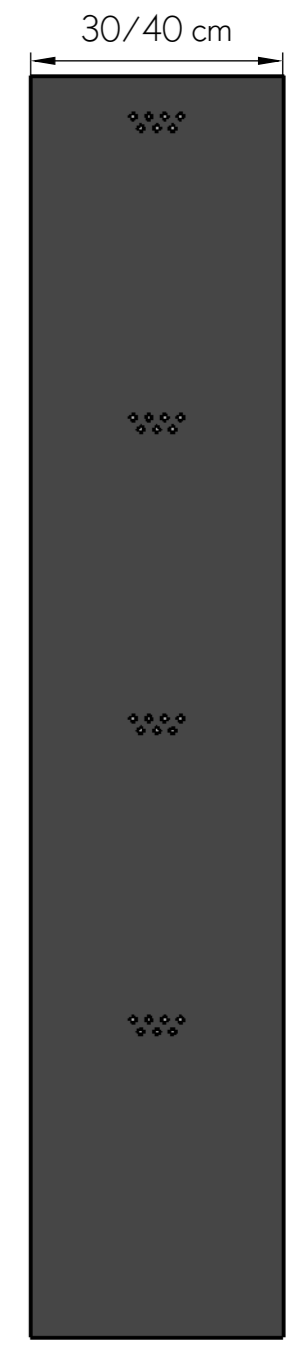

WIDOK Z TYŁU
WENTYLACJA

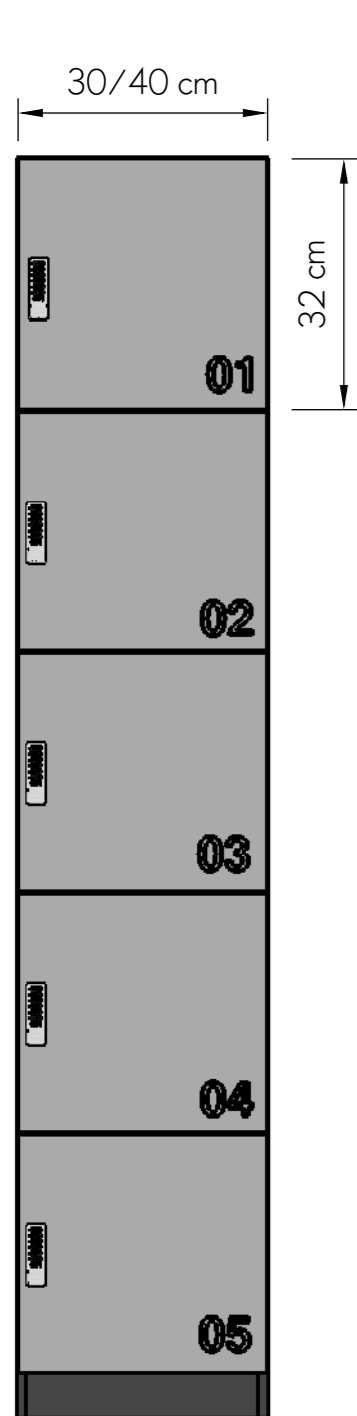

E5

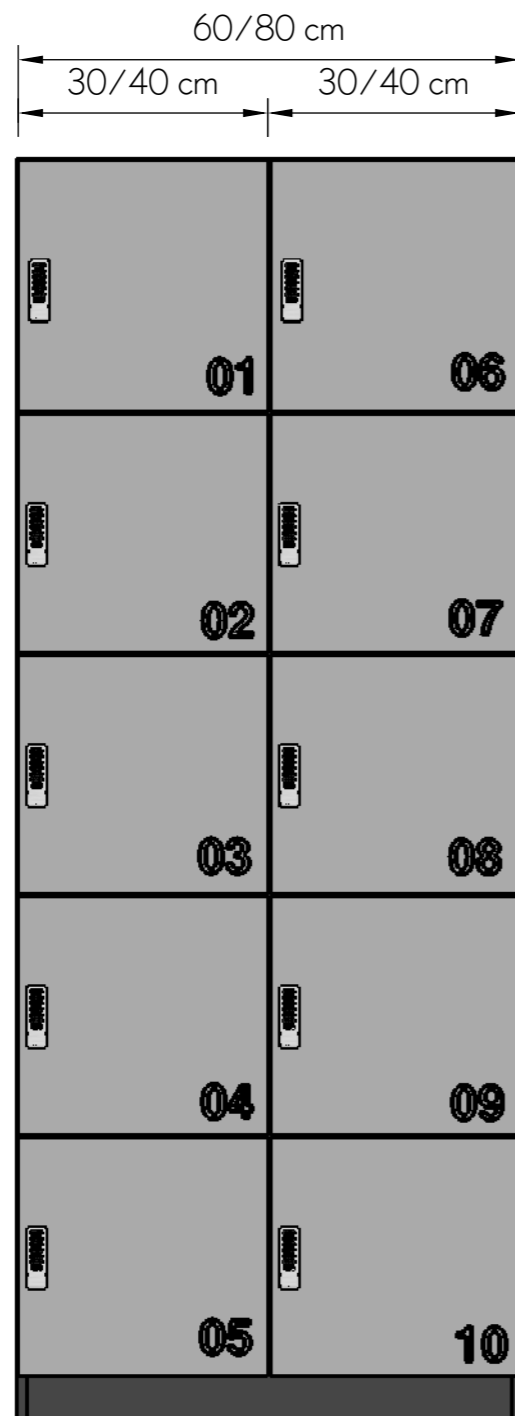

E10

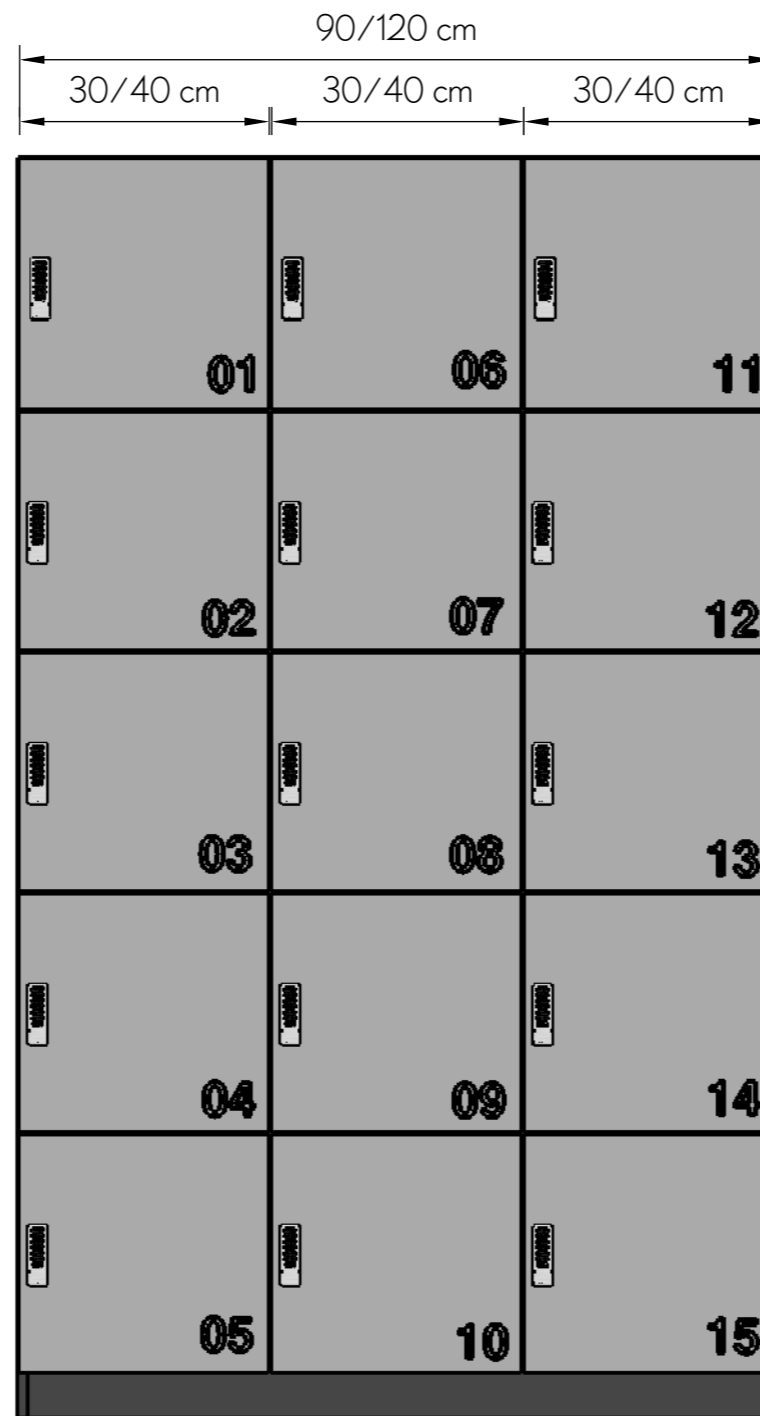

E15

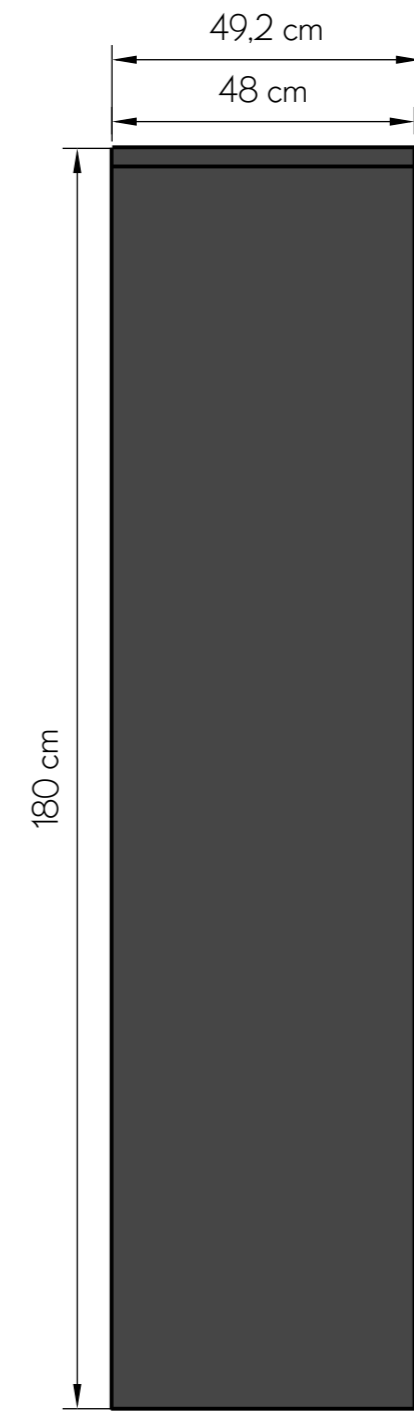

WIDOK Z BOKU

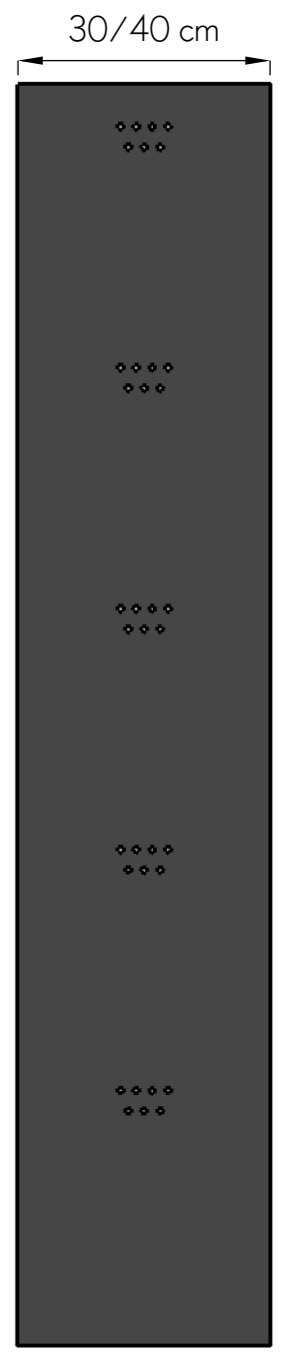

WIDOK Z TYŁU
WENTYLACJA

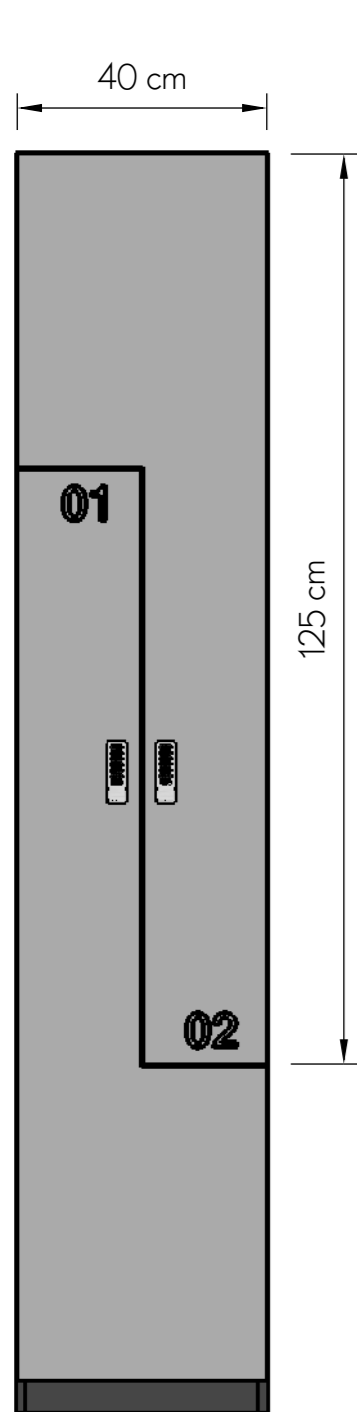

L2

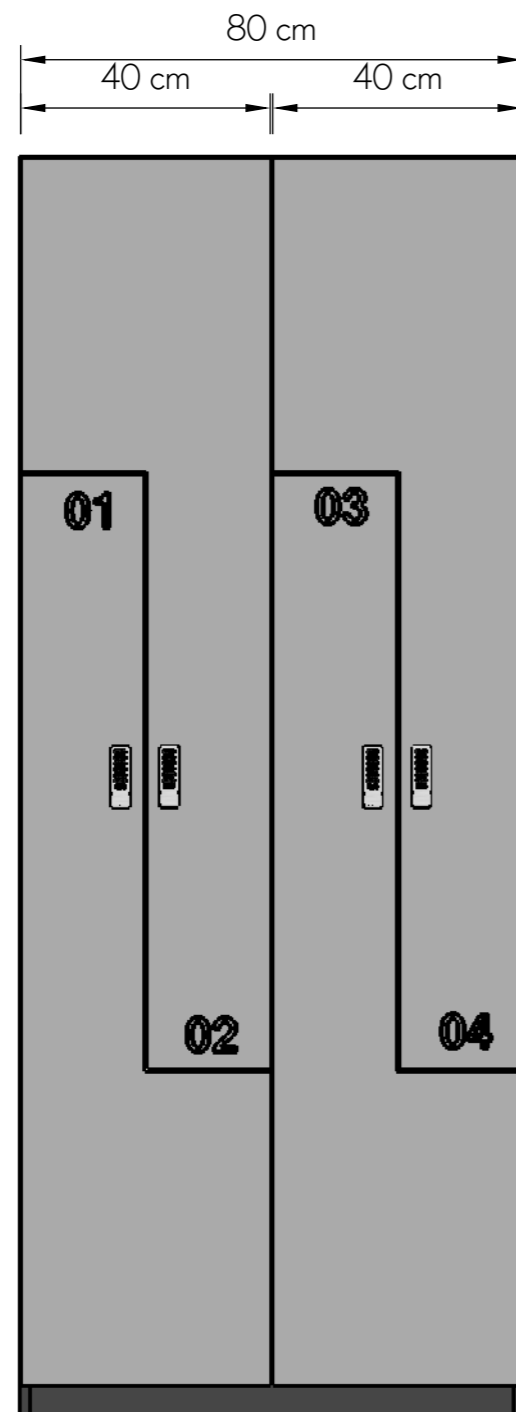

L4

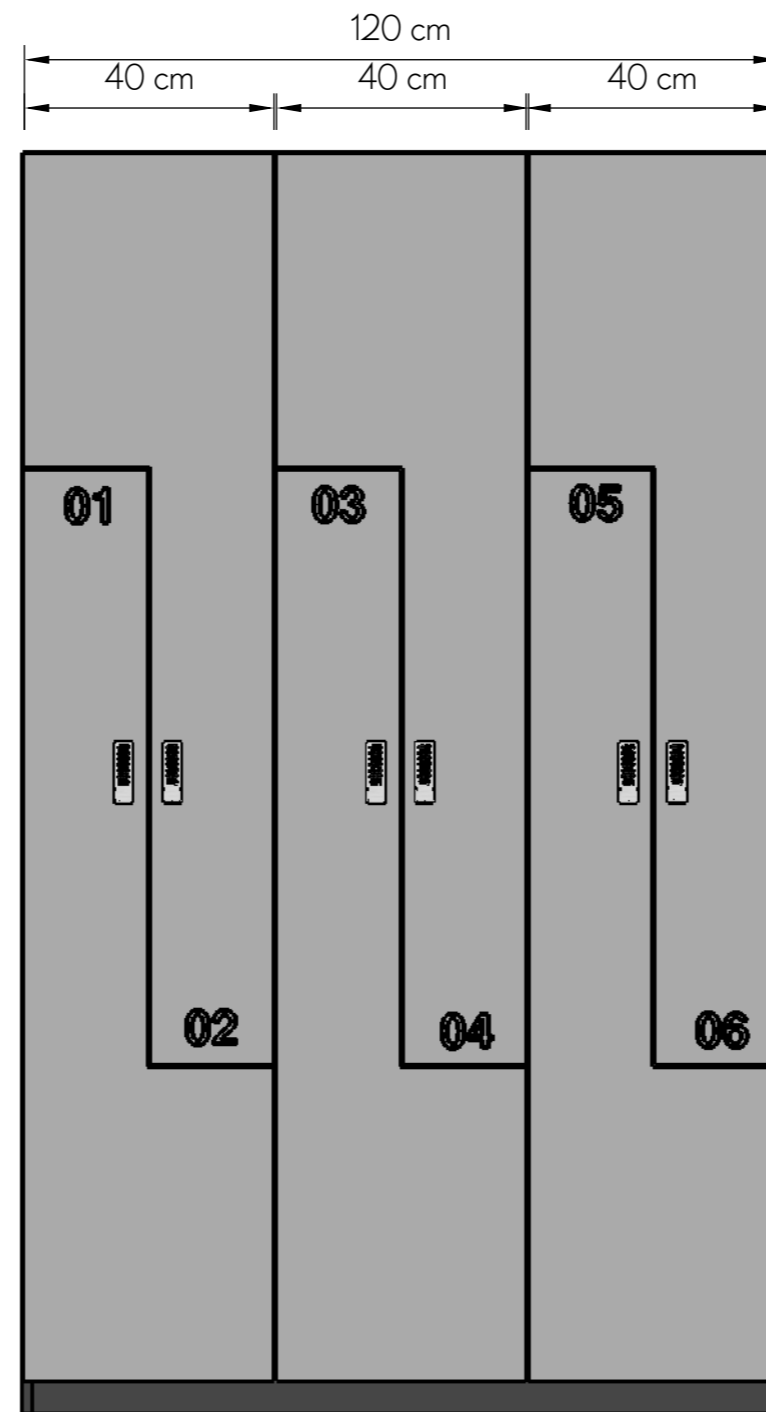

L6

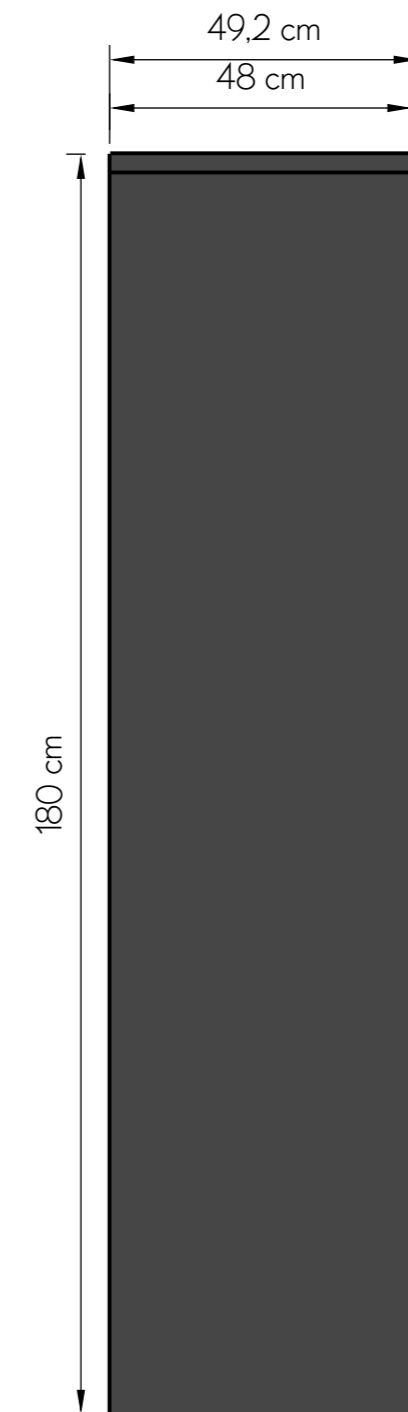

WIDOK Z BOKU

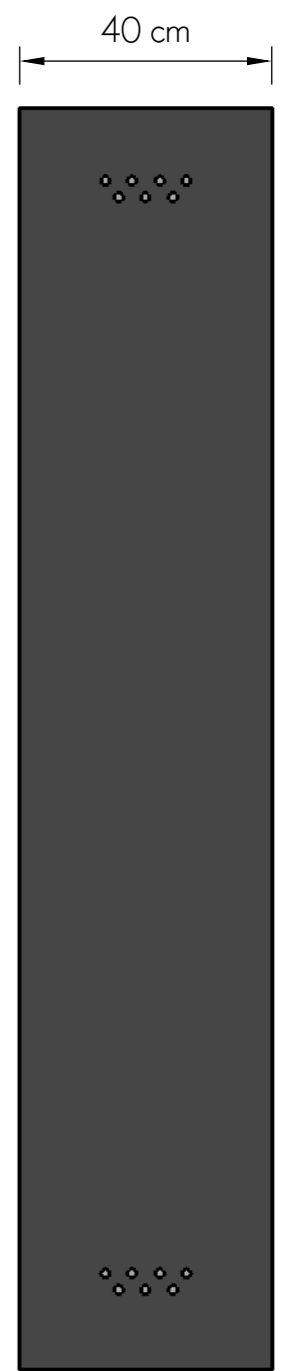

WIDOK Z TYŁU
WENTYLACJA

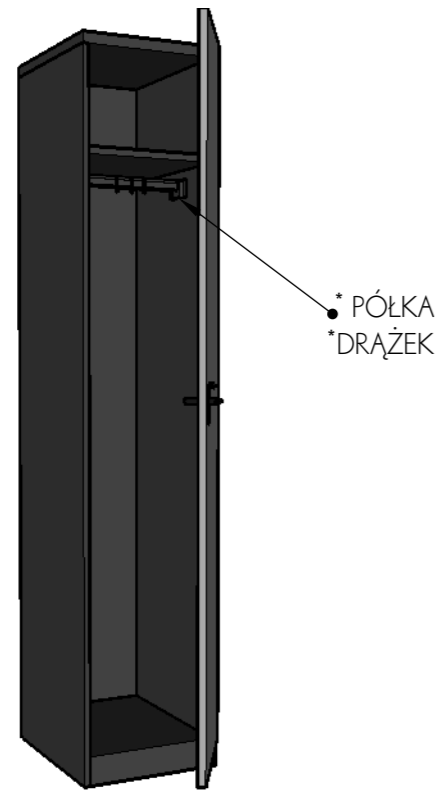

MODEL A
*DODATKOWA PÓŁKA
*DRAŻEK Z 3 HACZYKAMI

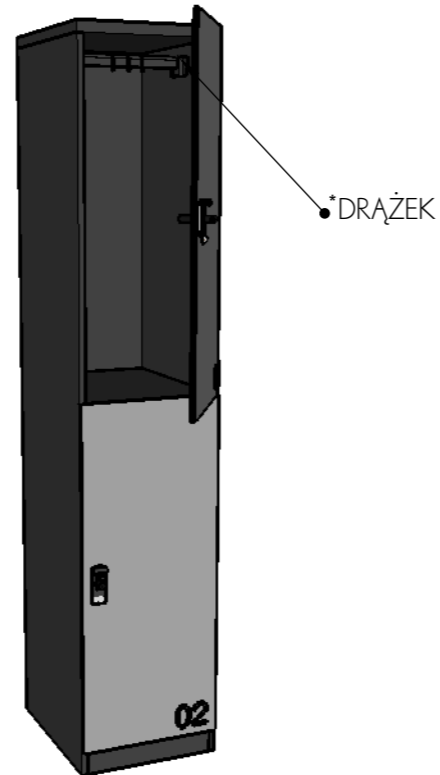

MODEL B
*DRAŻEK Z 3 HACZYKAMI

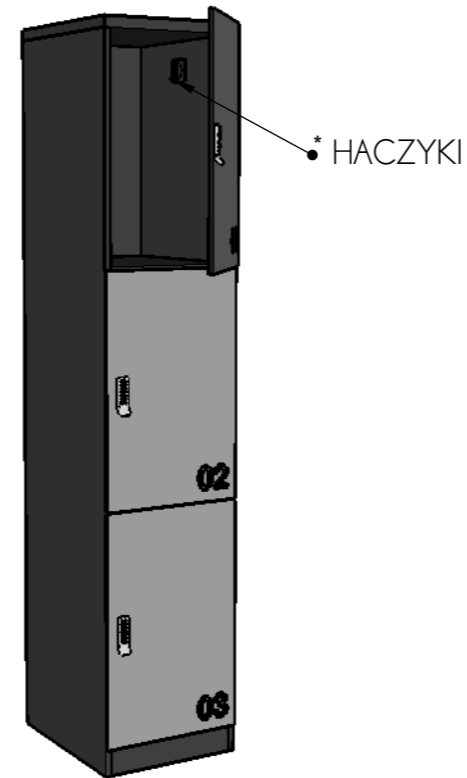

MODEL C
*DODATKOWE HACZYKI

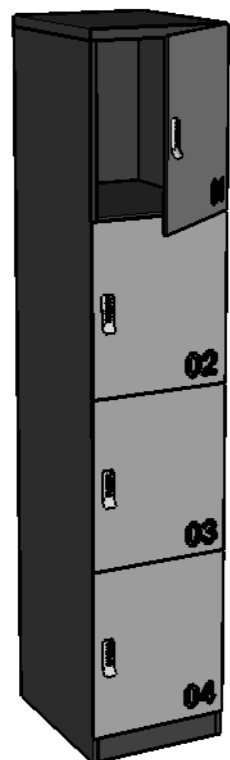

MODEL D

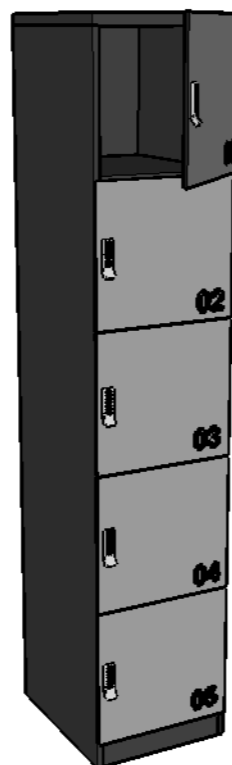

MODEL E

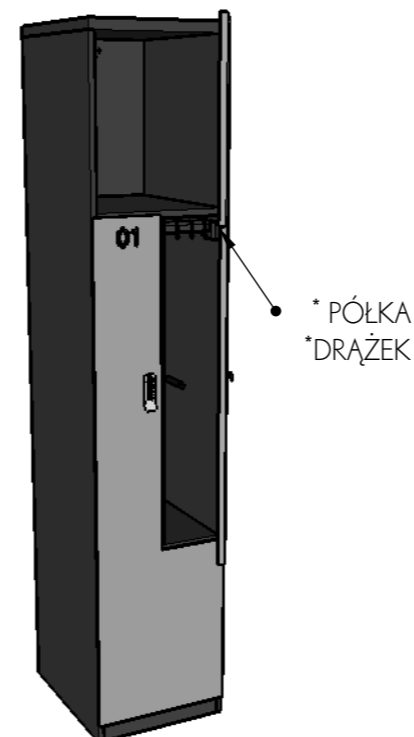

MODEL L
*DODATKOWA PÓŁKA
*DRAŻEK Z 3 HACZYKAMI

METALOWY KORPUS 0,8 MM



WERSJA PODSTAWOWA
RAL: 7024, 7016, 9003, 9004



PEŁNA KOLORYSTYKA Z PALETY RAL

FRONT
PŁYTA KOMPAKTOWA HPL12 MM

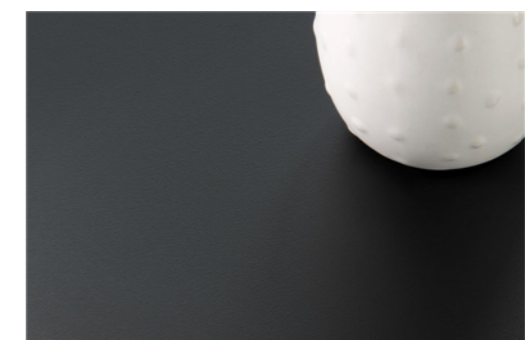

MONOKOLORY

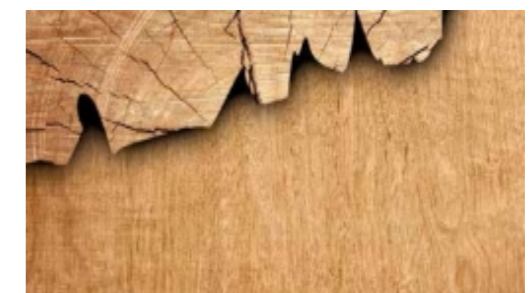

DEKORY DREWNOPODOBNE

WYMIARY STANDARDOWE

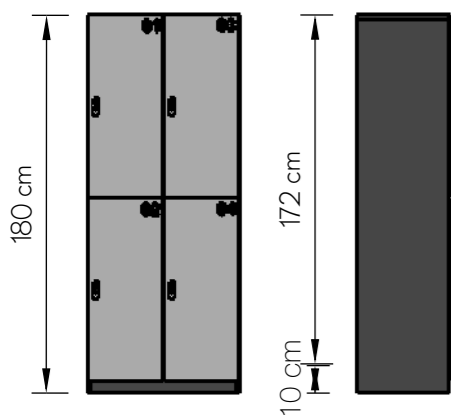

SZAFKA NA COKOLE

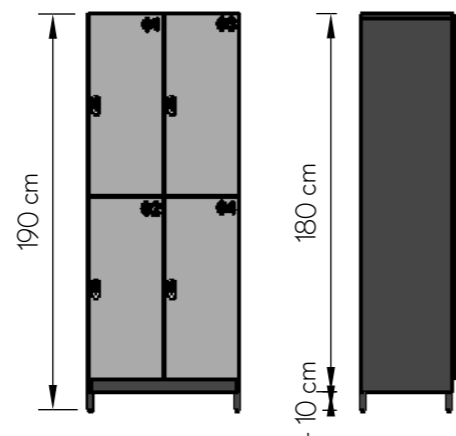

SZAFKA NA REGULOWANYCH
NÓŻKACH

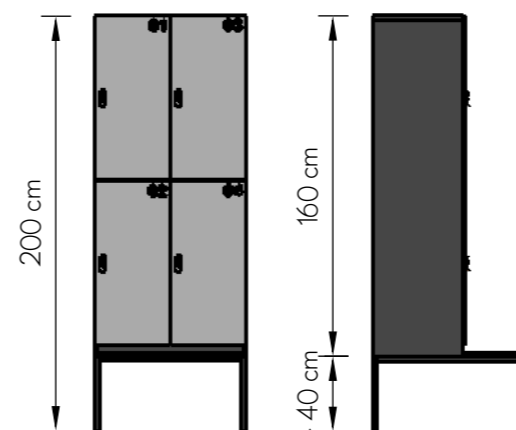

SZAFKA NA ŁAWCE Z PŁYTY HPL

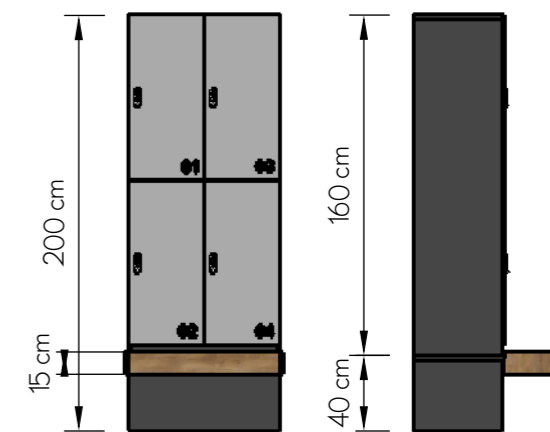

SZAFKA NA ŁAWCE LPP
Z PŁYTY HPL

WYMIARY NIESTANDARDOWE

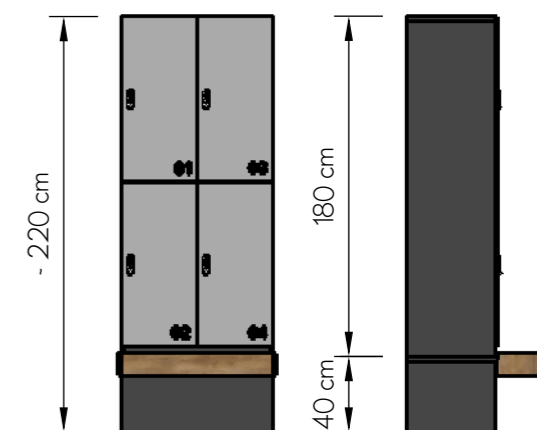
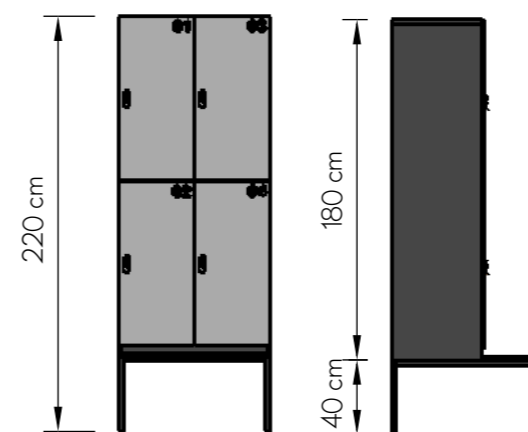
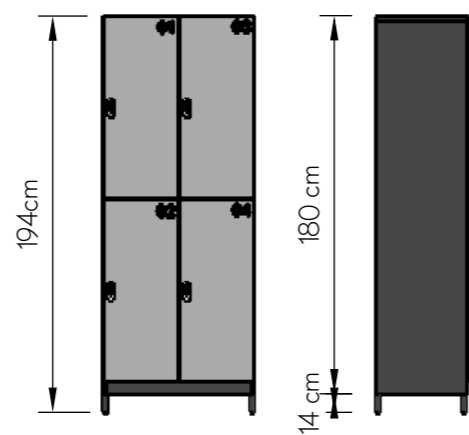
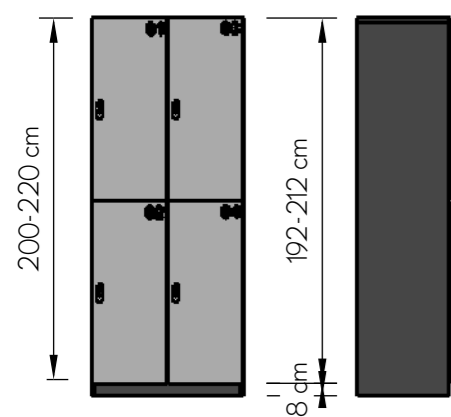

METALOWY KORPUS

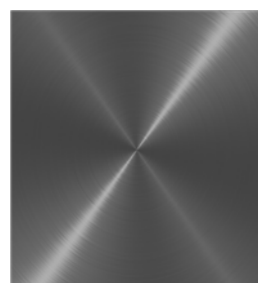

KORPUS WYKONANY JEST W WYSOKOGATUNKOWEGO METALU O GRUBOŚCI 0,8 MM. CAŁOŚĆ MAŁOWANA JEST PROSZKOWO WEDŁUG PALETY RAL. CERTYFIKAT POTWIERDZA WYKONANIE SZAFKI ZGODNIE Z POLSKIMI NORMAMI.

FRONT ORAZ SIEDZISKOZ PŁYTY KOMPAKTOWEJ HPL

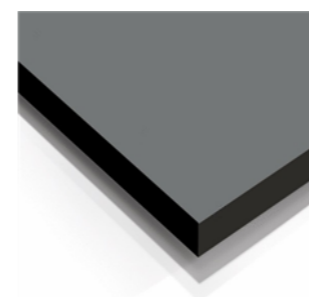

TO WARTWOWA PŁYTA WYSOKOCIŚNIENIOWA HPL PRODUKOWANA ZGODNIE Z NORMĄ EN 438-4 TYPU CGS DO WYMAGAJĄCYCH ZASTOSOWAŃ. POWIERZCHNIA NIE POSIADA PORÓW, JEST ŁATWA W DEZYNFEKCJI, ODPORNA NA AGRESYWNE, KWAŚNE ŚRODKI CZYSZCZĄCE.

