



thrislington cubicles

**thrislington cubicles** commercial

Aberdeen University Library    Aquatics Centre  
Assembly Rooms Edinburgh    Birmingham Library  
and REP Theatre    Birmingham New Street Station  
Birmingham Town Hall    Bristol Civic Justice Centre  
Bullring Shopping Centre    City of Westminster Courts  
Co-operative Group HQ    Cutty Sark    ExCel    Goldman  
Sachs    Peterborough Court    John Rylands Library  
Kings Cross Station    Liverpool John Lennon Airport  
London Eye    London South Bank    Lymington Yacht  
Haven Marina    Manchester Town Hall    Museum of  
Science & Industry    Neasden Mandir    NEC Birmingham  
Museum of Liverpool    Olympic Velodrome    Oriel  
Mostyn Gallery    Prince of Wales Theatre    Royal  
Liver Building    Serpentine Sackler Gallery    Snowdon  
Summit Café    Somerset House    St Georges Park  
St Pancras International    Wembley London Designer  
Outlet    Ellesmere Port    Westminster Cathedral  
Bay Atlantic, Lagos    British Council, Nairobi    Ibis  
Hotel, Lagos    Labadi Beach Hotel, Accra    Standard  
Chartered Bank, Nigeria    Yost Grube Hall, Lekki    3  
Connaught Road, Hong Kong    Arcapita Bank, Singapore

**We've been building the worlds best toilet cubicles at our factory in the United Kingdom since the 1960's.**

**Our passion is design, we've won countless awards over the years for our literature, advertising and most importantly our products.**

**We endeavour to use sustainable materials and the fact our products are designed to last so long is the key behind our environmental plan.**

**We've made our name through innovation, we love launching new systems, but anything we do launch will have been tested to within an inch of its life. To you it may seem new but to us we've been living with it for a lot longer.**

**It's this testing which means that we're so confident in our products, we are able to offer our unique ten year manufacturing guarantee.**

**1986**  
We shipped  
our cubicles  
overseas for  
the first time.  
This was  
the first time  
we shipped  
to the  
USA.



**1990**  
We launched  
our top of  
the range  
Alti system,  
designed  
for high end  
offices.

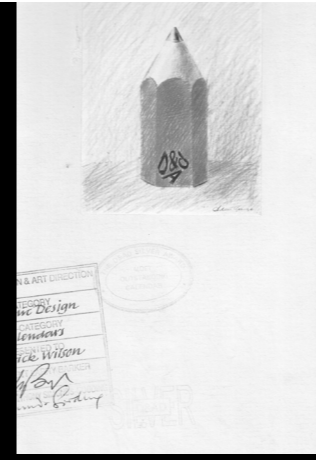

**1994**  
We won our  
first (of many)  
D&AD design  
awards for our  
1993 Calendar.

**1995**  
Won our  
second D&AD  
design award.

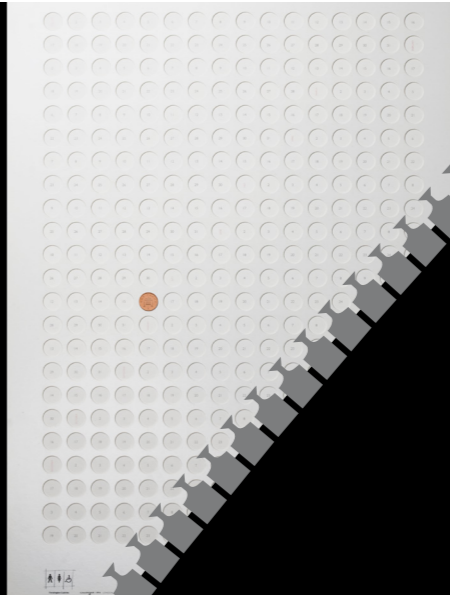

**1989**  
Our Combat  
cubicles were  
installed at the  
old Wembley  
Stadium.



1990	1991	1992	1993	1994
------	------	------	------	------

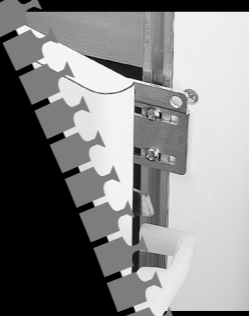

**1992**  
We created  
entry, our  
the duct  
system,  
with  
design  
the  
still  
to

**time flies** established 1968

# time flies

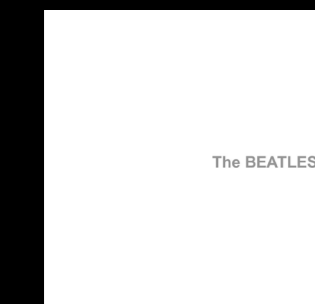

**1972**  
We moved to our first factory in Bromborough, Merseyside.



**1978**  
Our van started to deliver throughout the North of the UK.



**1982**  
Our salesmen began to go on the road country wide. Although it was hard to try and stay in constant contact with them...



**1986**  
We shipped our cubicles overseas for the first time. With jobs as far afield as Hong Kong.

**1984**  
Our first logo was created.



**1990**  
We launched our top of the range Alt system, designed for high end offices.



**1989**  
Our Combat cubicles were installed at the old Wembley Stadium.



**1994**  
We won our first (of many) D&AD design awards for our 1993 Calendar.

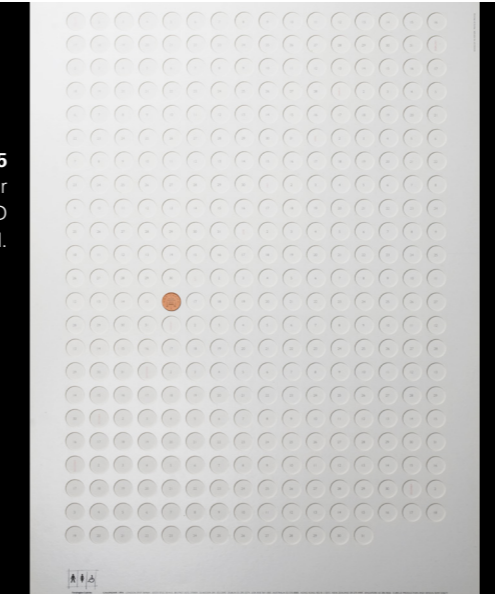

**1999**  
Our "Spend a Penny" Calendar was added to the permanent collection at the V&A.



thrislington cubicles



**2004**  
We fitted out the Museum of Modern Art - New York.



**2000**  
We first launched our Icon cubicle.

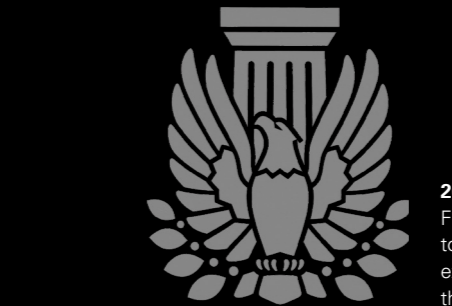

**2010**  
From Wales to Miami - we exhibited at the AIA 2010.



**2012**  
We fitted our Morgan Stanley's office in Times Square, New York, a job up to Gold LEED standard.



**2013**  
Our team today (with less dodgy moustaches).

1968 1969 1970 1971 1972 1973 1974 1975 1976 1977 1978 1979 1980 1981 1982 1983 1984 1985 1986 1987 1988 1989 1990 1991 1992 1993 1994 1995 1996 1997 1998 1999 2000 2001 2002 2003 2004 2005 2006 2007 2008 2009 2010 2011 2012 2013 2014 2015



**1968**  
We opened our first office (which was actually located inside this garage).



**1972**  
The first MD of the company was Brian Moore.



**1974**  
Jimmy Innes started work as a fitter - still doing the same today. (He can be seen fourth from the right on the back row of the 1986 photo to the right).



**1980**  
We moved to our current site in Sandycroft, Flintshire.



**1984**  
Our much loved Lotus cubicle was sold for the first time.



**1985**  
We won our first advertising award.

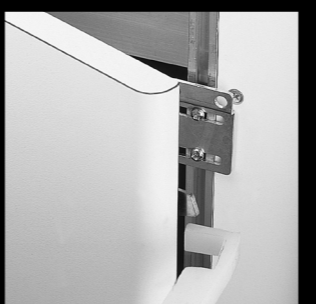
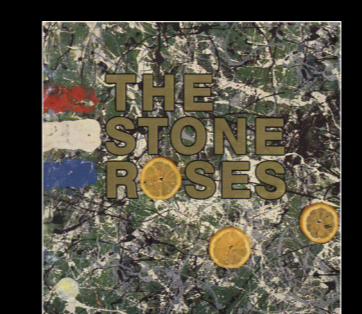

**1992**  
We created Sentry, our lockable duct access system, which, with some design revisions on the way, we still manufacture to this day.



**1993**  
Our Newspaper Calendar was released.



**1995**  
We fitted out Zaha Hadid's pavilion at the Blueprint Interbuild exhibition.



**2000**  
We were the first to sell toilet cubicles online with the launch of cubicplanet.com, which was based in the Port of Liverpool building.



THE STICKS IS THIS IT

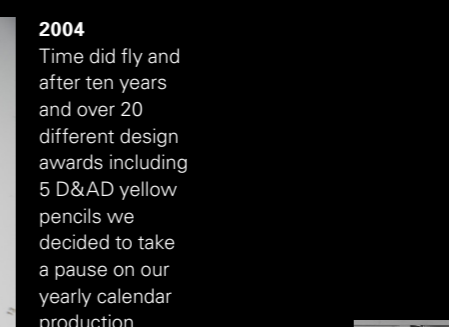

**2004**  
Time did fly and after ten years and over 20 different design awards including 5 D&AD yellow pencils we decided to take a pause on our yearly calendar production.



**2007**  
We won the DME, Design Management Europe award.

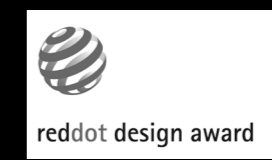

**2006**  
Our products won the coveted Red Dot design award.



**2008**  
We were entered into the Design Week Hall of Fame.



**2008**  
Flow - our flush full height system is developed and fitted for the first time.



**2014**  
Our intelligent glass systems launched including the spectacular Flowrite.



**2013**  
We won an IF design award for our recently launched Leisure range.



**2015**  
Coming soon, our dedicated health range.

# the ranges

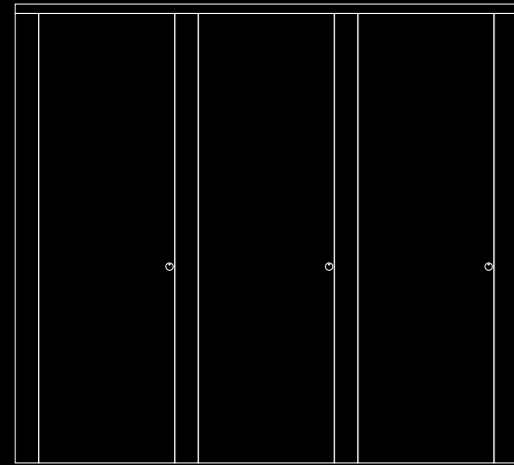

**flow** page 14  
flush, full height  
and beautiful

Non-visible full aluminium frame.  
Up to 2700mm high with 8mm floor gap.  
42mm rebated doors to ensure flush finish.  
Self-closing hydraulic door closer.  
Pivoted door.  
Stainless steel fittings.  
Machined stainless steel lock, complete with flush face plate, locates into integral receiver.  
Emergency release.  
10 year guarantee.

- Available in:
- Flowlite
  - Glass
  - Wood Veneer
  - Stainless Steel
  - Aluminium
  - High Pressure Laminate

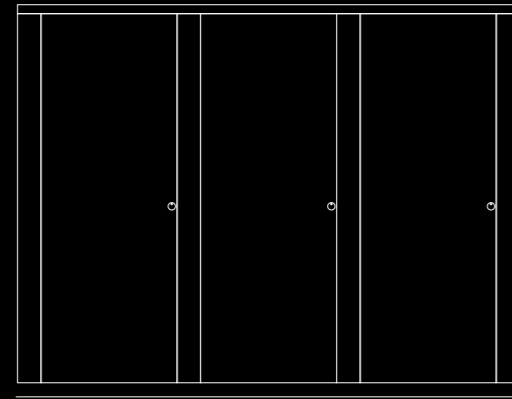

**ribbon** page 28  
a floating wall  
of cubicles

Non-visible full aluminium frame.  
Standard height of 2100mm with 100mm floor gap.  
Available up to 2500mm high.  
31mm rebated doors to ensure flush finish.  
Self-closing hydraulic door closer.  
Pivoted door.  
Stainless steel fittings.  
Machined stainless steel lock with flush face plate.  
Lock locates in post.  
Emergency release.  
10 year guarantee.

- Available in:
- Wood Veneer
  - Aluminium
  - High Pressure Laminate

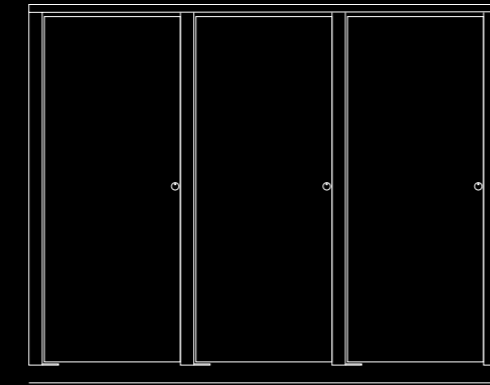

**oasis** page 38  
the cubicle  
that floats

Visible full aluminium frame.  
Standard height of 2000mm with 150mm floor gap.  
Available in certain finishes in full height version up to 2700mm with minimal floor gap.  
Anti-fingertrap.  
Lock locates into integral receiver.  
Self-closing hydraulic door closer.  
Pivoted door.  
Stainless steel fittings.  
Machined stainless steel lock.  
Emergency release.  
10 year guarantee.

- Available in:
- Oasis Smart
  - Glass
  - Wood Veneer
  - Stainless Steel
  - Aluminium
  - Compact Grade Laminate
  - High Pressure Laminate

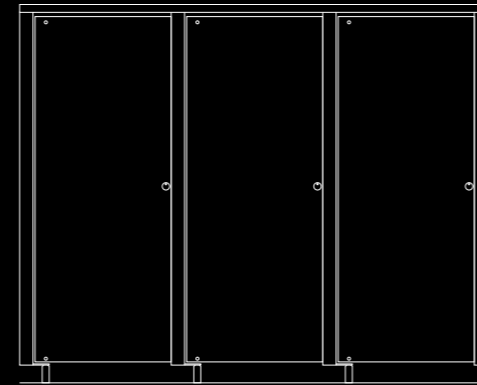

**icon** page 52  
a stunning  
all-rounder

Visible full aluminium frame.  
Standard height of 2000mm with 150mm floor gap.  
Available in certain finishes in full height version up to 2500mm with 100mm floor gap.  
Anti-fingertrap.  
Machined aluminium lock locates into post.  
Concealed self-closing door closer in foot.  
Pivoted door.  
Aluminium fittings.  
Emergency release.  
10 year guarantee.

- Available in:
- Glass
  - Wood Veneer
  - Stainless Steel
  - Aluminium
  - Compact Grade Laminate
  - High Pressure Laminate

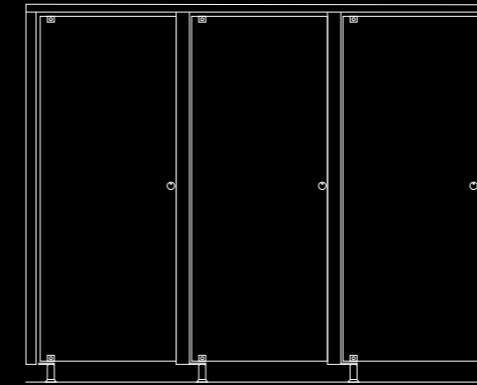

**polo** page 62  
value engineered  
perfection

Visible full powder coated aluminium frame.  
Standard height of 2000mm with 150mm floor gap.  
Available in full height version up to 2400mm with 28mm floor gap.  
Anti-fingertrap.  
Machined painted aluminium lock locates into post.  
Rise and fall self-closing door mechanism located in foot.  
Pivoted door.  
Powder coated aluminium fittings.  
Emergency release.  
10 year guarantee.

- Available in:
- Compact Grade Laminate
  - High Pressure Laminate

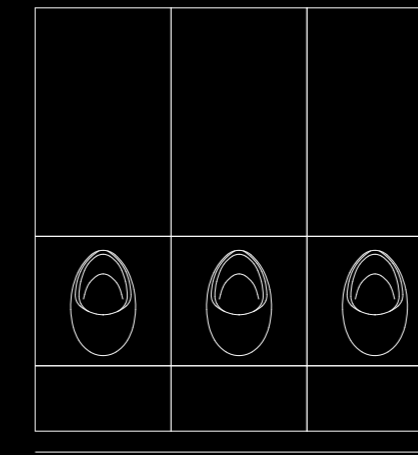

**sentry** page 72  
the versatile panel  
system that hinges

Full aluminium framework.  
Factory prefabricated access panel system.  
Up to 3000mm high.  
Available for toilet pans, urinals, wash-hand basins or simply wall panelling.  
Hinged access doors fastened by concealed catches.  
10 year guarantee.

- Available in:
- Glass
  - Wood Veneer
  - Stainless Steel
  - Aluminium
  - Compact Grade Laminate
  - High Pressure Laminate

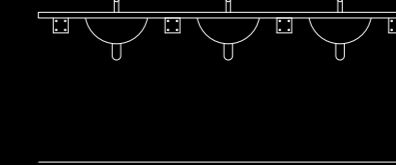

**vanity units** page 82  
an option for every  
washroom

Factory prefabricated.  
Variety of profiles.  
Optional access panels to conceal pipework.  
Supported by steel or aluminium framework.  
Available in a variety of designs.  
10 year guarantee.

- Available in:
- Glass
  - Granite
  - Concrete
  - Solid Surfaces
  - Compact Grade Laminate
  - High Pressure Laminate

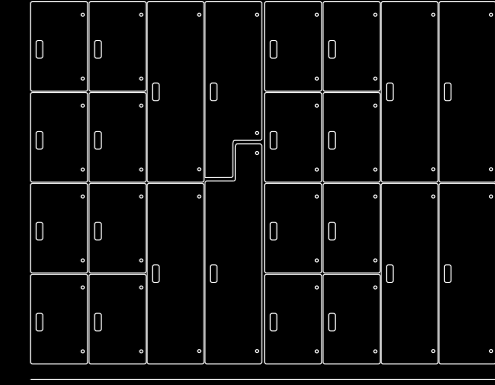

**fusion** page 92  
lockers the  
thrislington way

Aluminium body.  
Standard height of 1800mm.  
Various configurations, available, including z-lockers.  
Variable depths and widths.  
Full extruded integral door frames and hinges.  
Range of locking options.  
Designed for wet and humid conditions.  
Can work with differing plinth options  
10 year guarantee.

- Available in:
- Glass
  - Wood Veneer
  - Aluminium
  - Compact Grade Laminate
  - High Pressure Laminate

# our unique selling points

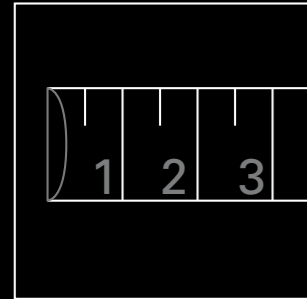

## made to measure

Like the ultimate Savile Row suit, all our cubicles, panels and vanity units are made specifically for each individual room, this ensures that for every job specified they become the perfect fit.

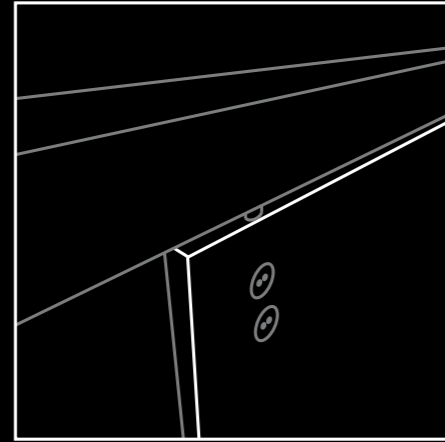

## self-closing doors

From our top of the range hydraulic closing system to a simple rise and fall mechanism, all our doors are designed to self close leaving your washroom looking as neat as you intended.

## 10 year warranty

We offer a no fuss - 10 year manufacturing guarantee. All of our products are built to stand the test of time, which we believe to be critical to our environmental strategy.

# 10

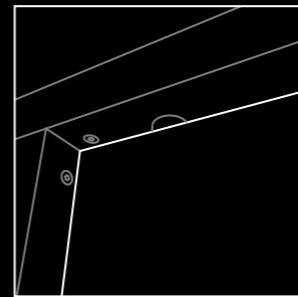

## full aluminium framework

We like to think that people often choose Thrislington because of how the cubicles look but they come back to order again, because of how they work. The strength behind all our cubicles is the full aluminium framework.

## pivoted doors

Our doors open by pivoting from a headrail, to either a bracket, foot or the floor meaning all our cubicles are free of hinges, which are the weak point of any door. The pivot system also provides the opportunity to increase or decrease clearances around the door, which can create an anti-finger trap facility if desired.

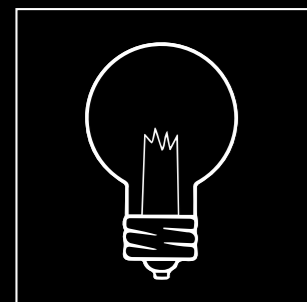
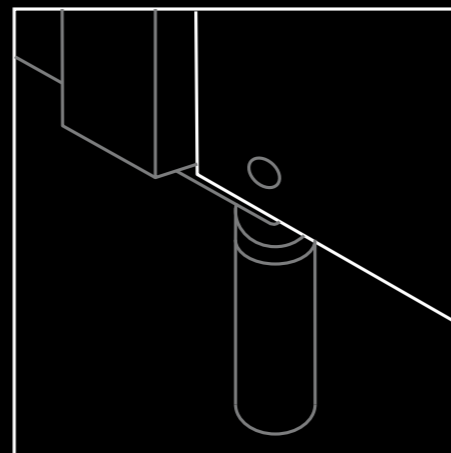

## innovation

We have always tried to stay one step ahead of our competition by creating innovative new product features, such as our new electronic Flowlite and Oasis Smart systems.

## minimalist fixings

Our products are as minimalist as possible, with clean lines and uncluttered panels. Even when visible fixings are essential, we employ neat yet very tough architectural fixings.

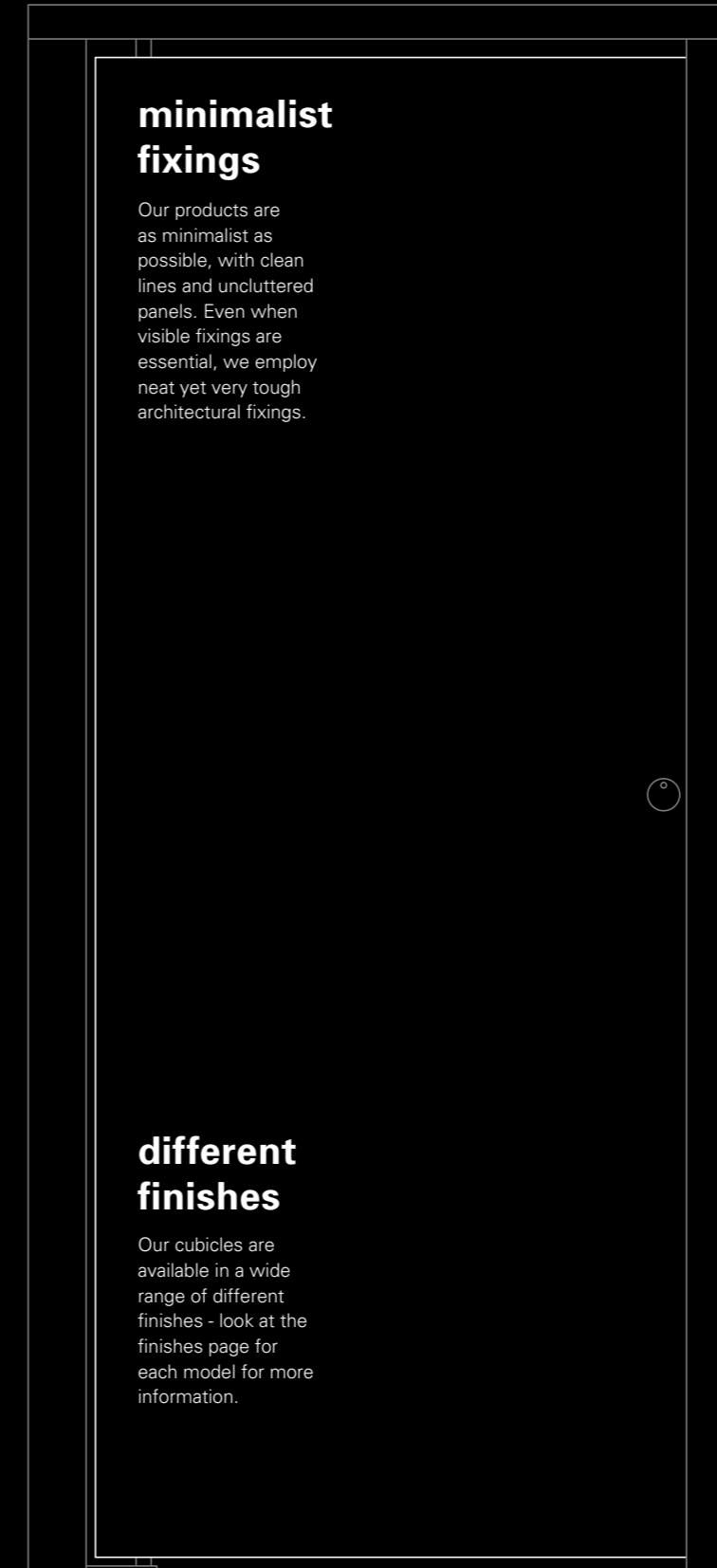

## different finishes

Our cubicles are available in a wide range of different finishes - look at the finishes page for each model for more information.

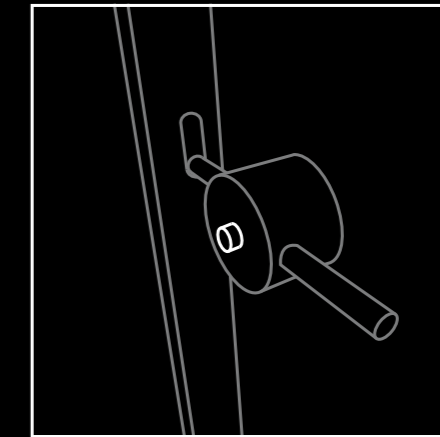

## integrated locking mechanism

Unlike a normal latch and bolt system our locks are designed to integrate directly into the aluminium frame of our cubicles and are through fixed for added strength. They also all have our unique shear point at the tip which is designed to snap if a door is kicked through. This point is quick and inexpensive to fix.

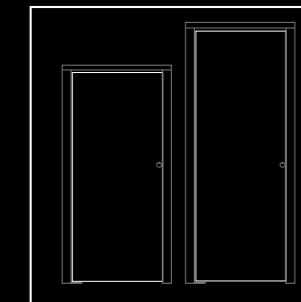

## bespoke design

We like to think we know everything there is to know about washroom design, but that doesn't mean that we are not open to new ideas. With our unique bespoke design service we are able to work with you, to create your ideal specification.

## environmental policy

All of our core materials are sourced from sustainable managed forests. We are also able to supply core materials with no added urea formaldehyde (NAUF), with zero VOC adhesives, to achieve BREEAM and LEED certification where specified. All our aluminium has a high recycled content.



Our new system, unrivalled in the cubicle world, can change colour by the second and can even link to the lock, creating a different colour cubicle whether open or closed.

Built using the same tried and tested technology behind our Flow system in glass, this truly is the premier system from the world's premier cubicle supplier.

**flowlite**

As soon to be seen in W Hotel, Liverpool.



flowlite



To see flowlite move go to [www.thisingtoncubicles.com/flowlite](http://www.thisingtoncubicles.com/flowlite)



# flow

The last word in elegance, all flow doors close to a completely flush finish with 42mm thick hydraulically closing doors and hand lipped rebates. Stainless steel fittings complete the system.

Available in flowlite, glass, wood veneer, stainless steel, aluminium and high pressure laminate.

As seen in Ferrari World, Abu Dhabi.

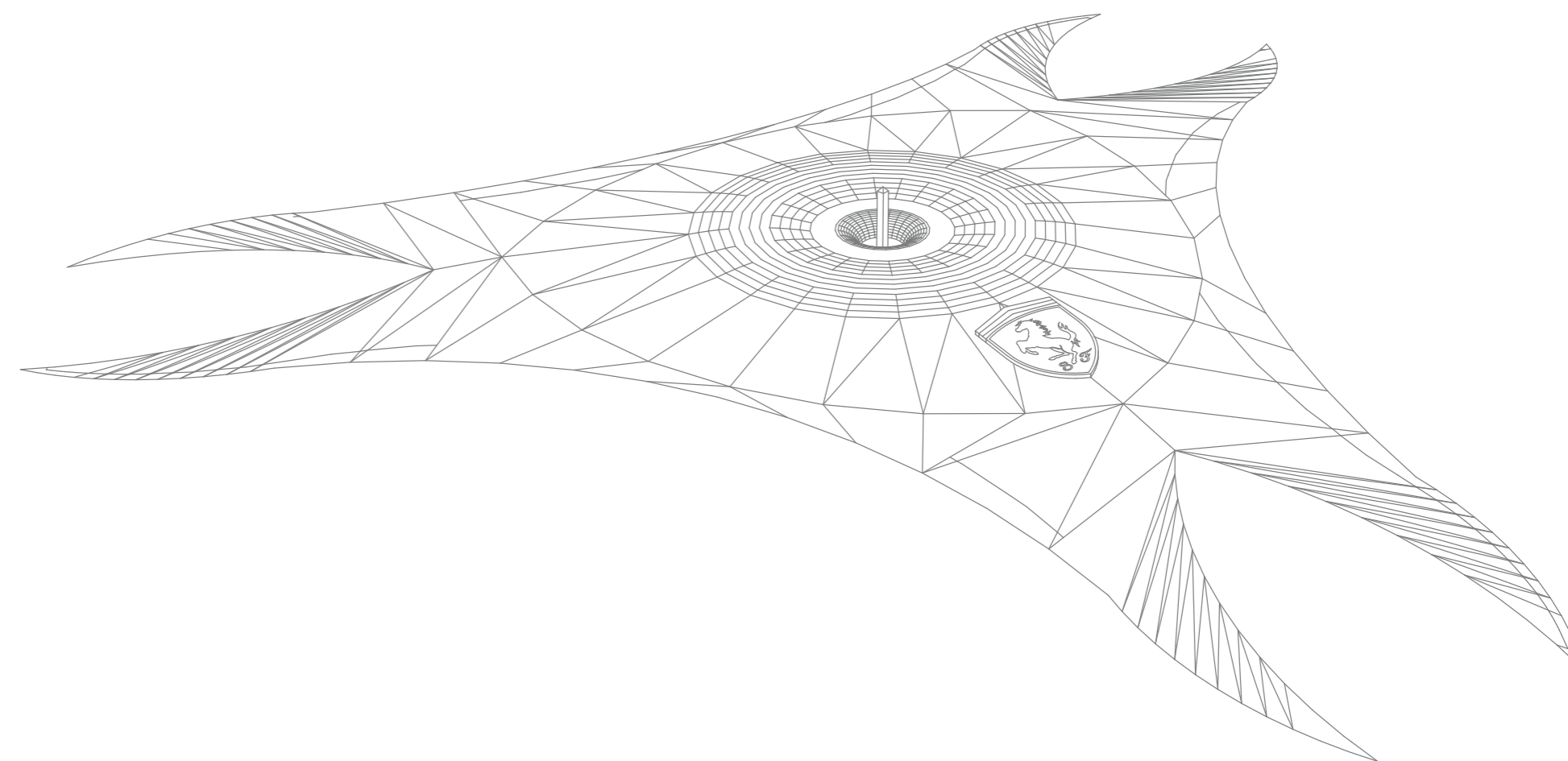

flow



flow in glass trough in solid surface sentry in aluminium

Features:

Non-visible full aluminium frame.  
Up to 2700mm high with 8mm floor gap.  
42mm rebated doors to ensure flush finish.  
Self-closing hydraulic door closer.  
Pivoted door.  
Stainless steel fittings.  
Machined stainless steel lock, complete with flush face plate, locates into integral receiver.  
Emergency release.  
10 year guarantee.

Available in:

- Flowlite
- Glass
- Wood Veneer
- Stainless Steel
- Aluminium
- High Pressure Laminate



flow surfaces and finishes			k32	
material	options	examples	Specification: Overall cubicle height up to 2700mm with an 8mm floor clearance.	Framework: Full anodised aluminium frame, with extruded headrail finished with matching finish. Lock locates into receiver integrated within the vertical fascia.
<p><b>glass</b></p> <p>Back painted glass.</p>	<ul style="list-style-type: none"> <li>● Flowlite</li> <li>● Low-Iron</li> <li>● Clear</li> <li>● Range of standard colours</li> <li>● RAL match on request</li> </ul>		<p><b>Door:</b> 42mm finished thickness consisting of a 29mm ultra lightweight MDF core, faced in high pressure laminate, then rebated and hand-lipped, to accept 5mm low-iron back painted toughened glass to both faces. Concealed fixings within the door allow attachment to stainless steel pivots, suspended from aluminium headrail and located onto floor fixed pivot bracket. Door falls closed by means of a hydraulic door closer concealed within the aluminium headrail (alternatively, the closer can be factory set to fall open).</p> <p><b>Divider:</b> 37mm finished thickness consisting of a 25mm moisture resistant chipboard core, faced in high pressure laminate and finished to top and bottom edges. Two adjacent 5mm low-iron back painted toughened glass panels, bonded to each face. Suspended 8mm from the floor using concealed fixings (alternatively, the divider can be located in a floor channel).</p>	
<p><b>wood veneer</b></p> <p>Real wood veneer backed with composite material to enable fabrication.</p>	<ul style="list-style-type: none"> <li>● Matt</li> <li>● Silk</li> <li>● Relief</li> <li>● Grained</li> <li>● Unfinished</li> <li>● Optional cross grain</li> </ul>		<p><b>Door:</b> 42mm finished thickness consisting of a 40mm ultra lightweight MDF core, rebated first, hand-lipped and faced with wood veneer. Concealed fixings within the door allow attachment to stainless steel pivots, suspended from aluminium headrail and located onto floor fixed pivot bracket. Door falls closed by means of a hydraulic door closer concealed within the aluminium headrail (alternatively, the closer can be factory set to fall open).</p> <p><b>Divider:</b> 27mm finished thickness consisting of a 25mm moisture resistant chipboard core, edged top and bottom, then faced with wood veneer. Suspended 8mm from the floor using concealed fixings (alternatively, the divider can be located in a floor channel).</p>	
<p><b>metallic</b></p> <p>Metallic sheet bonded to MDF core, edge dependent on material.</p>	<ul style="list-style-type: none"> <li>● Brushed stainless steel</li> <li>● Patterned stainless steel</li> <li>● Satin anodised aluminium</li> <li>● Powder coated aluminium</li> </ul>		<p><b>Door:</b> 43mm finished thickness consisting of a 40mm composite core panel, rebated first, hand-lipped in matching high pressure laminate and faced with 1.5mm stainless steel sheet. Concealed fixings within the door allow attachment to stainless steel pivots, suspended from aluminium headrail and located onto floor fixed pivot bracket. Door falls closed by means of a hydraulic door closer concealed within the aluminium headrail (alternatively, the closer can be factory set to fall open).</p> <p><b>Divider:</b> 27mm finished thickness consisting of a 25mm moisture resistant chipboard core, faced with 1mm stainless steel sheet, folded on top and bottom edges. Maximum depth of dividing panel, without a butt joint in the face material, is 1500mm. With a butt joint, the divider depth can be up to 1980mm. Suspended 8mm from the floor using concealed fixings (alternatively, the divider can be located in a floor channel).</p>	
<p><b>laminate</b></p> <p>Multiple layers of resin-impregnated high quality kraft papers.</p>	<ul style="list-style-type: none"> <li>● High Pressure Laminate</li> <li>● Extensive range of colours</li> <li>● Wide selection of suppliers</li> <li>● Colour match on request</li> <li>● Digital prints</li> <li>● Wood grains</li> </ul>		<p><b>Door:</b> 42mm finished thickness consisting of a 40mm ultra lightweight MDF core, rebated first, hand-lipped and faced with high pressure laminate. Concealed fixings within the door allow attachment to stainless steel pivots, suspended from aluminium headrail and located onto floor fixed pivot bracket. Door falls closed by means of a hydraulic door closer concealed within the aluminium headrail (alternatively, the closer can be factory set to fall open).</p> <p><b>Divider:</b> 27mm finished thickness consisting of a 25mm moisture resistant chipboard core, edged top and bottom, then faced with high pressure laminate. Suspended 8mm from the floor using concealed fixings (alternatively, the divider can be located in a floor channel).</p>	

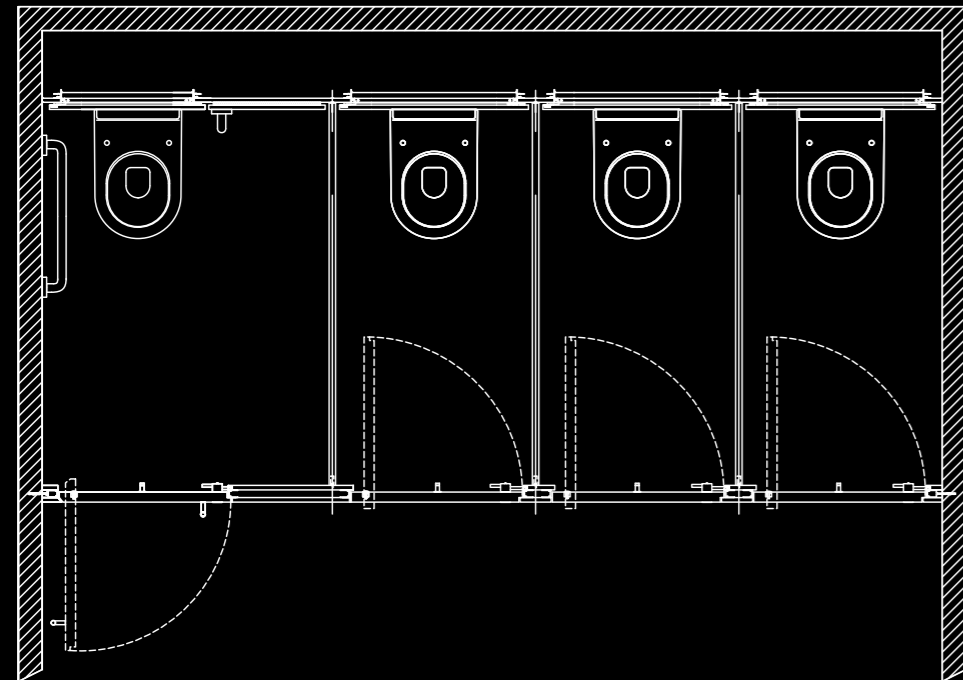

### typical layout

As shown in a run of four between walls including Sentry access panels with one open-out disabled cubicle.

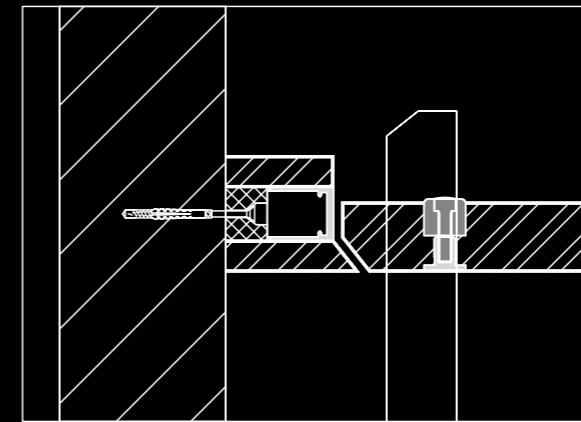
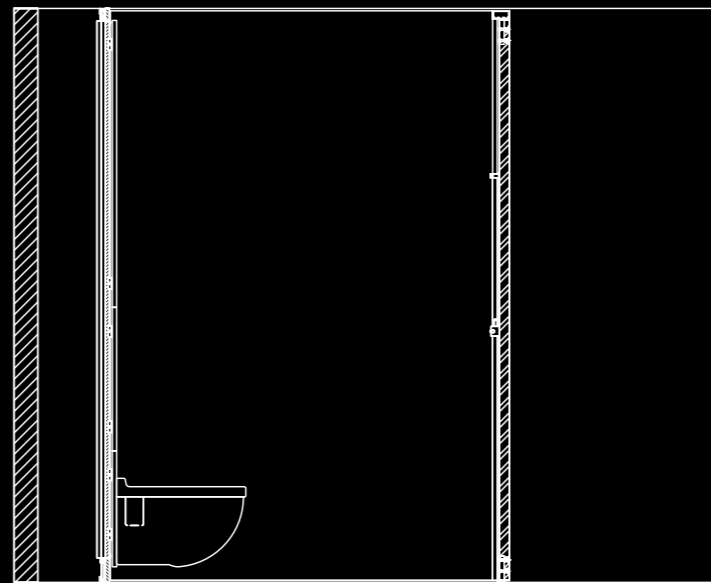
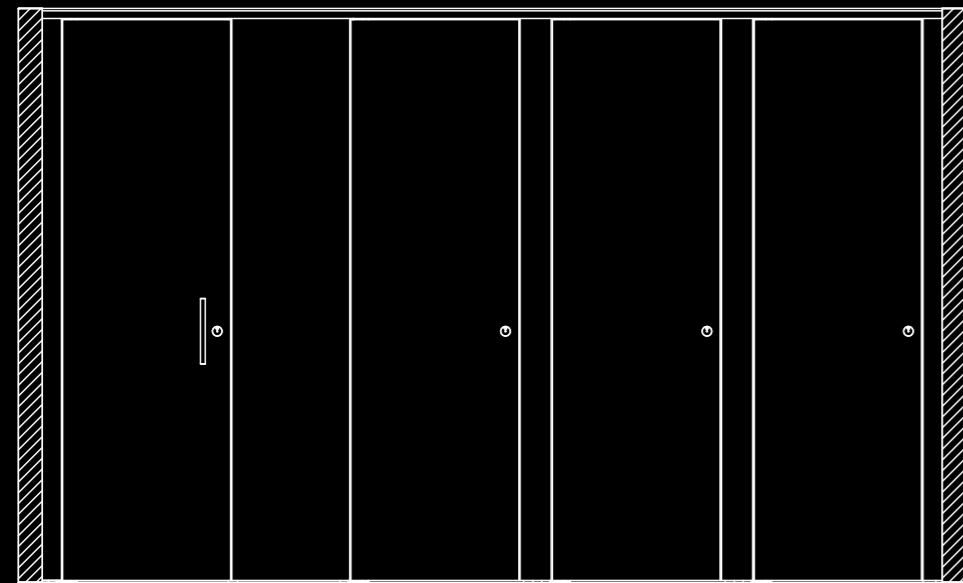

Detail 1

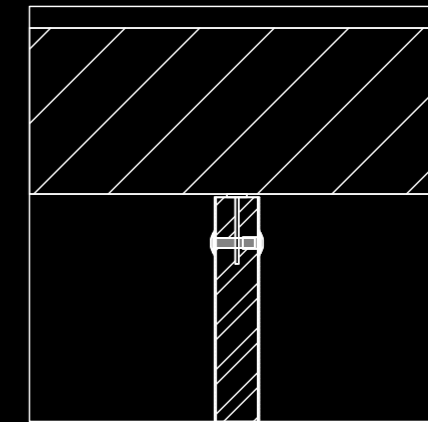

Detail 4

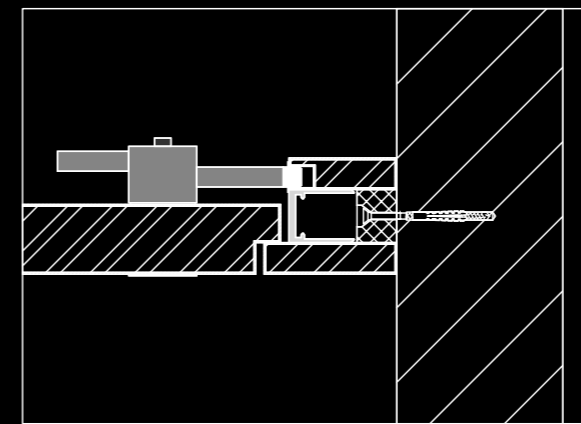

Detail 2

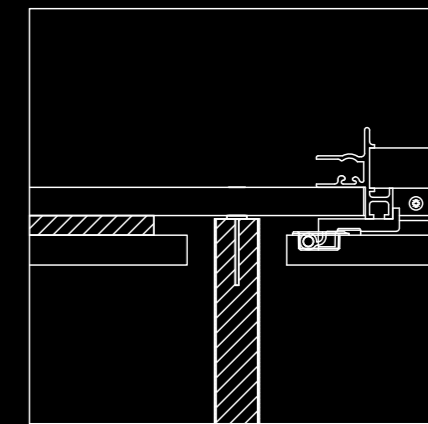

Detail 5

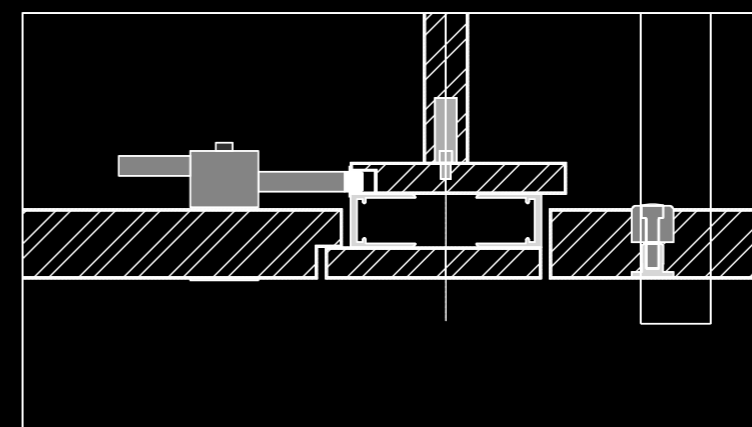

Detail 3

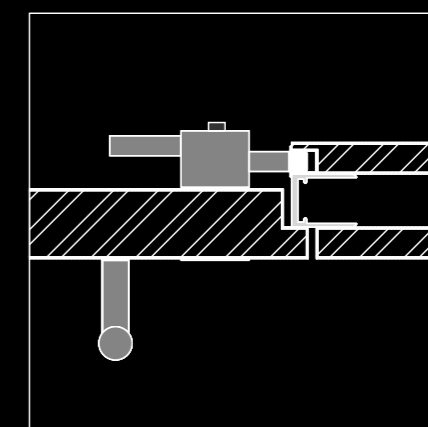

Detail 6



thrislington cubicles

Product: Flow

Layout: Common details are shown, but the system is designed to be as adaptable as possible, and will fit almost any layout.

Detail 1: Wall hinge outward opening fascia

Detail 2: Wall close inward fascia

Detail 3: Centre hinge inward/ close inward fascia

Detail 4: Divider to bracket fixing against a wall

Detail 5: Divider to bracket fixing against a sentry infill

Detail 6: Outward opening close fascia

# ribbon

A floating wall of cubicles. Simply beautiful. Comprising of a stepped back stainless steel foot, fully engineered integral lock and concealed hydraulic door closer.

Ribbon is available in wood veneer, aluminium and high pressure laminate.

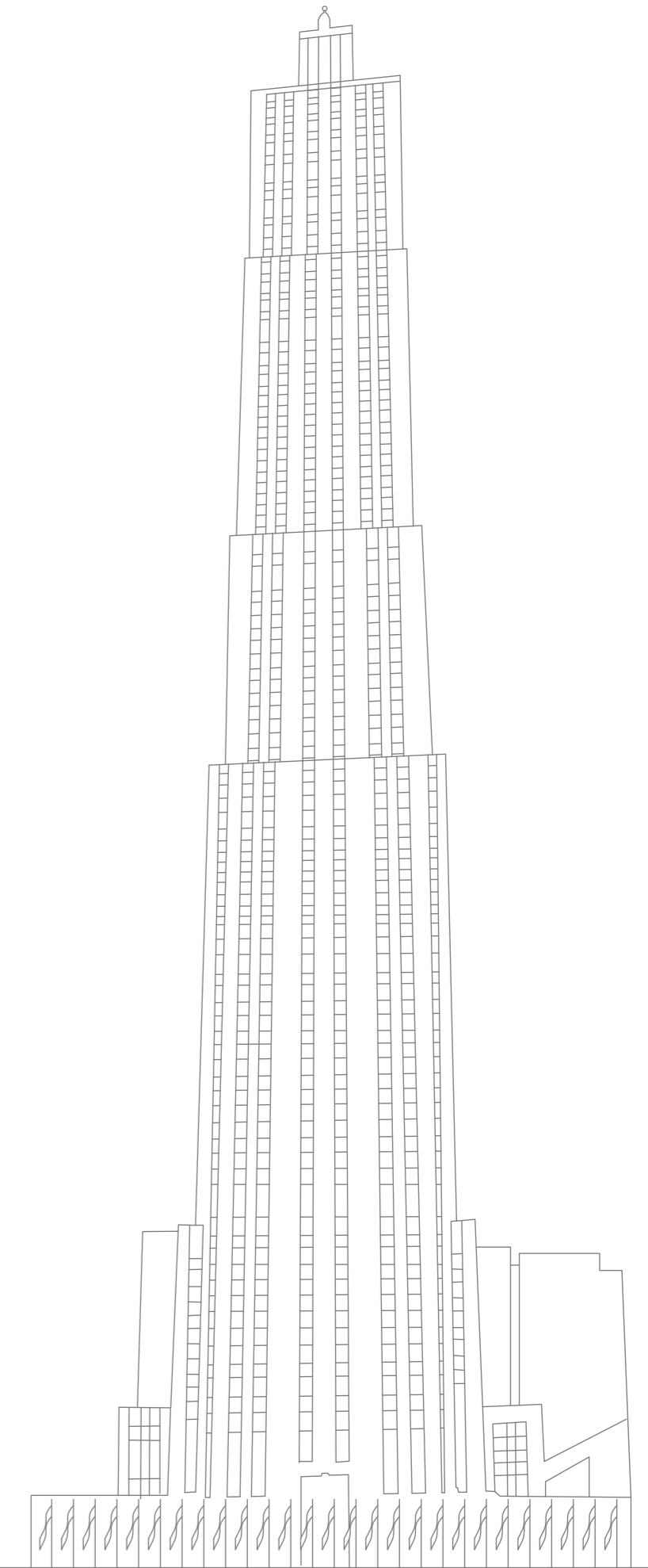

As seen in the Rockefeller Centre, New York.

ribbon



ribbon in wood veneer sentry in high pressure laminate trough in solid surface

# ribbon

## Features:

Non-visible full aluminium frame.  
Standard height of 2100mm with 100mm floor gap.  
Available up to 2500mm high.  
31mm rebated doors to ensure flush finish.  
Self-closing hydraulic door closer.  
Pivoted door.  
Stainless steel fittings.  
Machined stainless steel lock with flush face plate.  
Lock locates in post.  
Emergency release.  
10 year guarantee.

## Available in:

- Wood Veneer
- Aluminium
- High Pressure Laminate





ribbon surfaces and finishes			<b>k32</b> <b>Specification:</b> Overall cubicle height up to 2100mm with 100mm floor clearance. Available up to 2500mm high.  <b>Framework:</b> Full anodised aluminium frame, with extruded headrail. Lock locates directly into vertical closing post, with integral full length buffer.
material	options	examples	
<b>wood veneer</b> Real wood veneer backed with composite material to enable fabrication.	<ul style="list-style-type: none"> <li>● Matt</li> <li>● Silk</li> <li>● Relief</li> <li>● Grained</li> <li>● Unfinished</li> <li>● Optional cross grain</li> </ul>		<p><b>Door:</b> 31mm finished thickness consisting of a 29mm ultra lightweight MDF core, rebated first, hand-lipped and faced with wood veneer. Concealed fixings within the door allow attachment to stainless steel pivot blocks, suspended from aluminium headrail and located onto a bottom pivot bracket. Door falls closed by means of a hydraulic door closer concealed within the aluminium headrail (alternatively, the closer can be factory set to fall open).</p> <p><b>Divider:</b> 17mm finished thickness consisting of a 15mm moisture resistant chipboard core, edged top and bottom, then faced with wood veneer. Supported 100mm from the floor using an engineered 304 grade stainless steel foot, with height adjustment.</p> <p><b>Fascia:</b> 62mm finished thickness consisting of a 12mm moisture resistant MDF core, edged first and faced with wood veneer, bonded to an aluminium extrusion.</p>
<b>metallic</b> Metallic sheet bonded to MDF core, edge dependent on material.	<ul style="list-style-type: none"> <li>● Satin anodised aluminium</li> <li>● Brushed aluminium</li> <li>● Powder coated aluminium</li> </ul>		<p><b>Door:</b> 31mm finished thickness consisting of a 29mm ultra lightweight MDF core, rebated first, hand-lipped in matching high pressure laminate and faced in sheet aluminium. Concealed fixings within the door allow attachment to stainless steel pivot blocks, suspended from aluminium headrail and located onto a bottom pivot bracket. Door falls closed by means of a hydraulic door closer concealed within the aluminium headrail (alternatively, the closer can be factory set to fall open).</p> <p><b>Divider:</b> 17mm finished thickness consisting of a 15mm moisture resistant chipboard core, edged top and bottom in matching High Pressure Laminate, then faced in sheet aluminium. Supported 100mm from the floor using an engineered 304 grade stainless steel foot, with height adjustment.</p> <p><b>Fascia:</b> 62mm finished thickness consisting of a 12mm moisture resistant MDF core, edged first in matching high pressure laminate, faced in sheet aluminium and bonded to an aluminium extrusion.</p>
<b>laminate</b> Multiple layers of resin-impregnated high quality kraft papers.	<ul style="list-style-type: none"> <li>● High Pressure Laminate</li> <li>● Extensive range of colours</li> <li>● Wide selection of suppliers</li> <li>● Colour match on request</li> <li>● Wood grains</li> <li>● Digital prints</li> </ul>		<p><b>Door:</b> 31mm finished thickness consisting of a 29mm ultra lightweight MDF core, rebated first, hand-lipped and faced with High Pressure Laminate. Concealed fixings within the door allow attachment to stainless steel pivot blocks, suspended from aluminium headrail and located onto a bottom pivot bracket. Door falls closed by means of a hydraulic door closer concealed within the aluminium headrail (alternatively, the closer can be factory set to fall open).</p> <p><b>Divider:</b> 17mm finished thickness consisting of a 15mm moisture resistant chipboard core, edged top and bottom, then faced with High Pressure Laminate. Supported 100mm from the floor using an engineered 304 grade stainless steel foot, with height adjustment.</p> <p><b>Fascia:</b> 62mm finished thickness consisting of a 12mm moisture resistant MDF core, edged first and faced with high pressure laminate, bonded to an aluminium extrusion.</p>

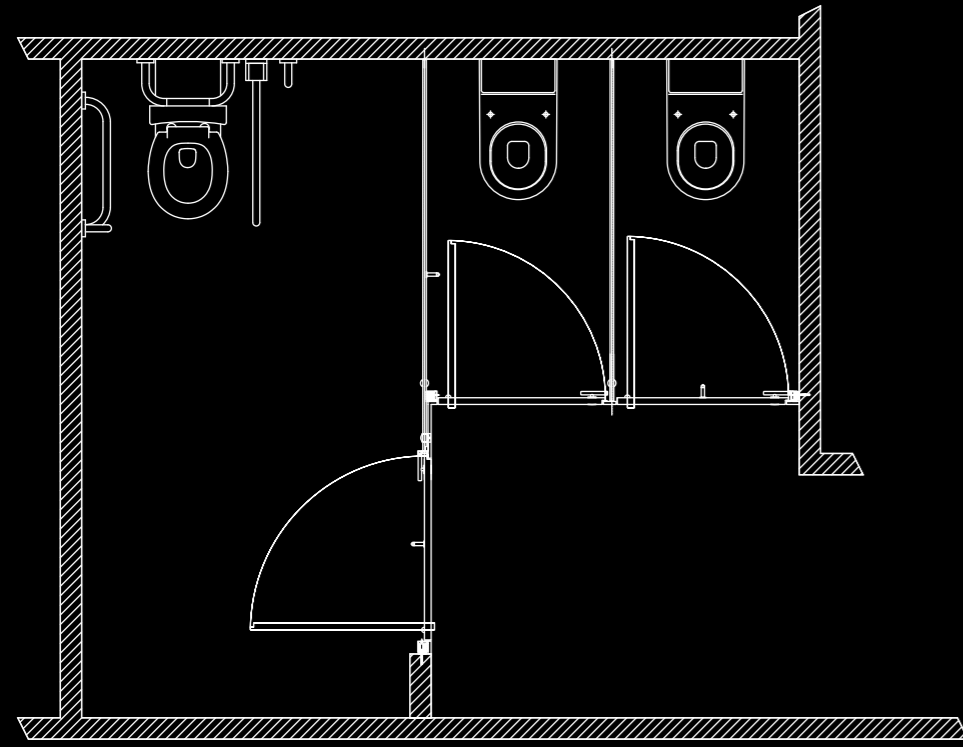

**typical layout**

As shown as a run of three with one large disabled cubicle.

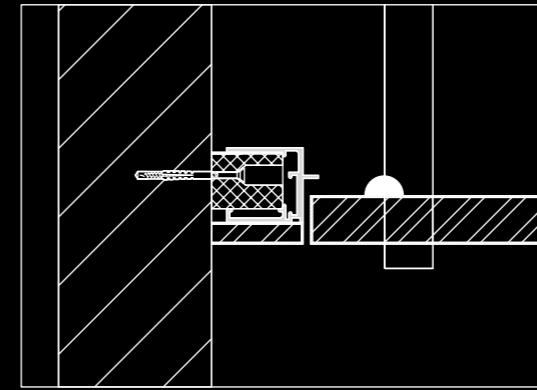
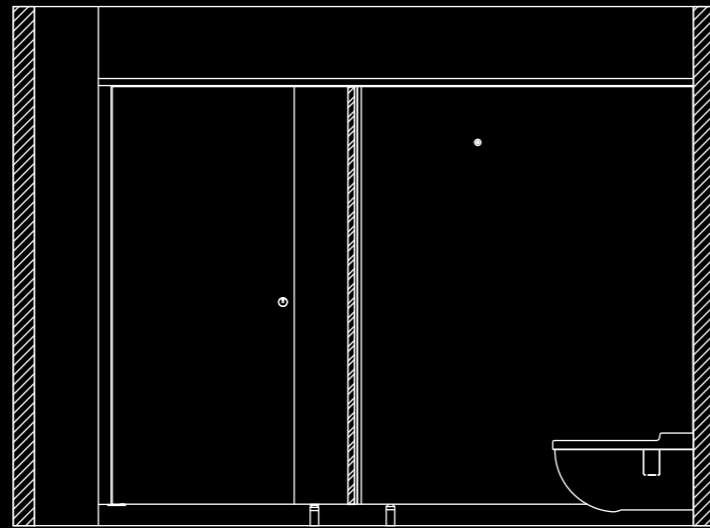
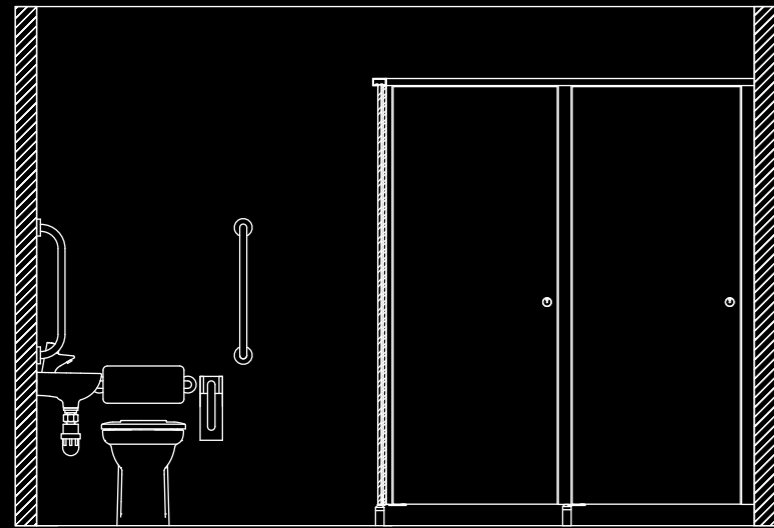

Detail 1

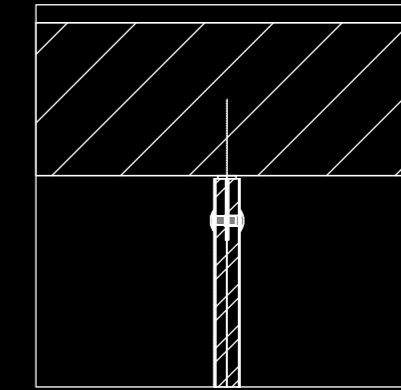

Detail 4

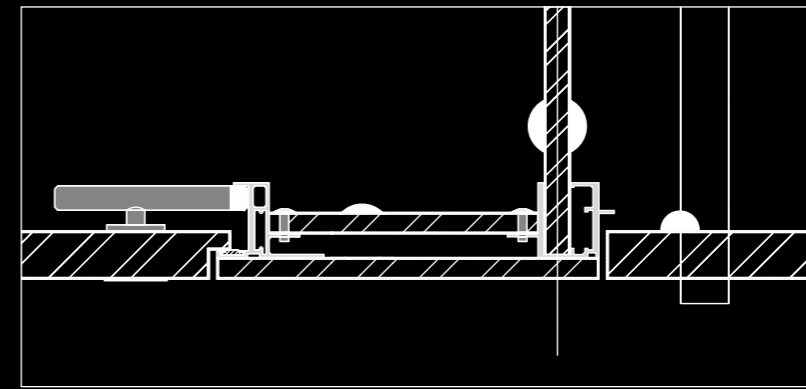

Detail 2

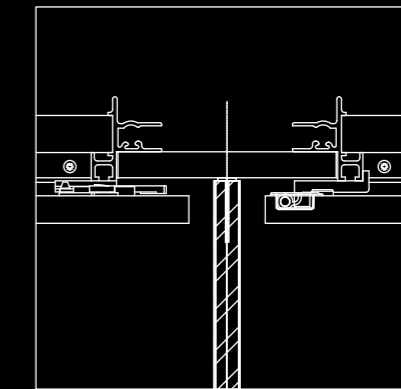

Detail 5

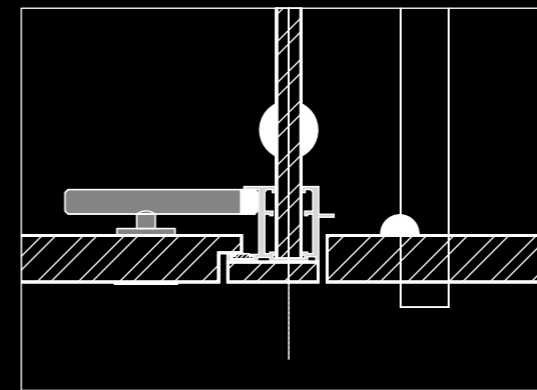

Detail 3

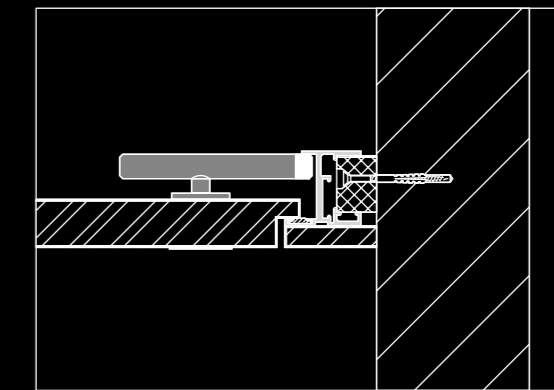

Detail 6



thrislington cubicles

Product: Ribbon

Layout: Common details are shown, but the system is designed to be as adaptable as possible, and will fit almost any layout.

Detail 1: Wall Hinge Inward.

Detail 2: Fascia Close in / Fascia Hinge Inward.

Detail 3: Centre Hinge In / Close Inward.

Detail 4: Divider to bracket fixing against a wall

Detail 5: Divider to bracket fixing against a Sentry infill

Detail 6: Wall close inward

As seen in Paris Charles de Gaulle airport.

Our other new system, designed to change the way we see washroom space. The doors shift from being transparent to opaque as soon as the lock is engaged.

Built using the same technology behind our Oasis glass system, this is a revolutionary system from a revolutionary cubicle supplier.

## oasis smart

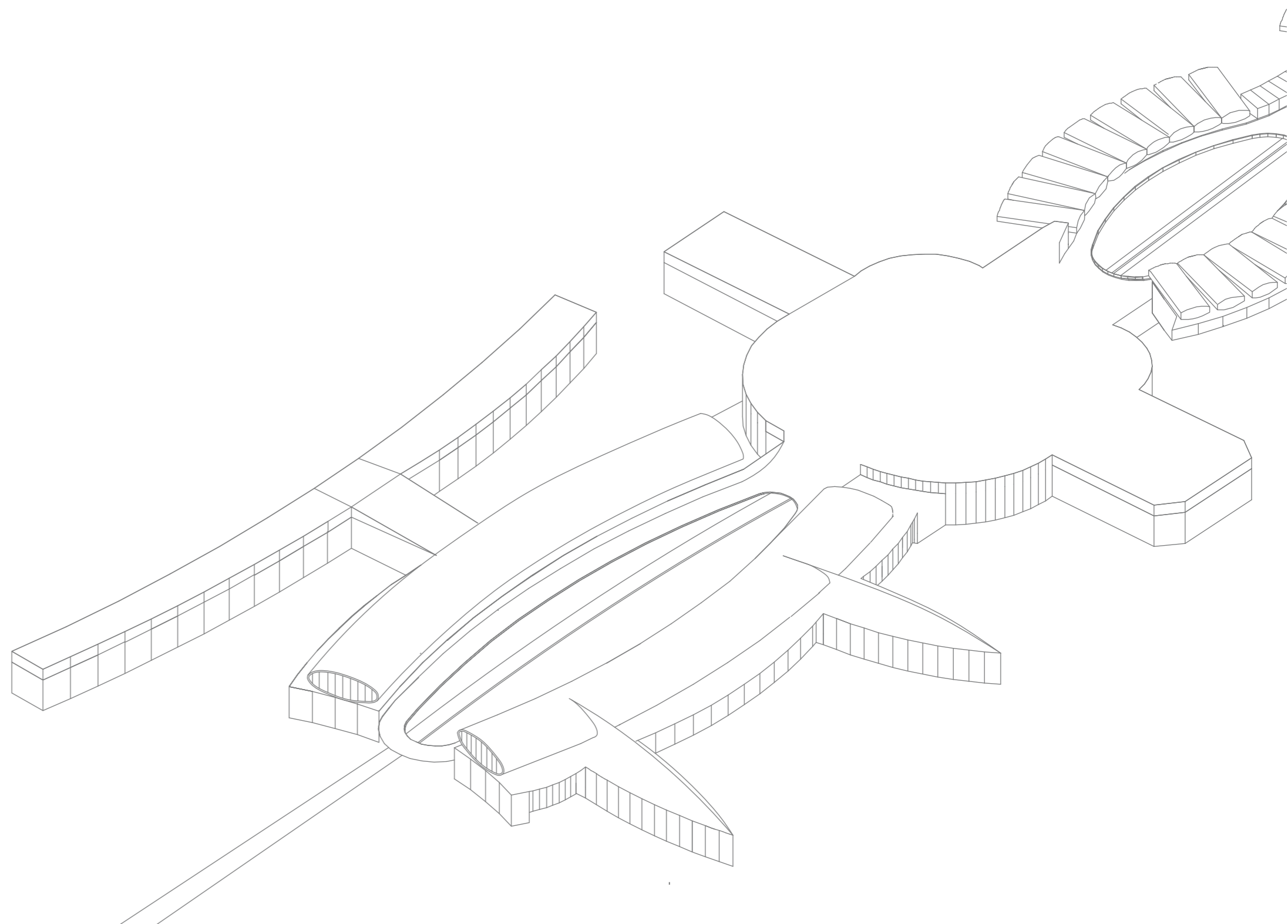

# oasis smart



To see oasis smart move go to [www.thringtoncubicles.com/oasismart](http://www.thringtoncubicles.com/oasismart)

# oasis

Our groundbreaking floating cubicle. Along with intelligent placement of the foot we've suspended Oasis from the headrail to create what appears to be a fully aluminium framed cubicle that floats.

Available in wood veneer, stainless steel, aluminium, glass, compact grade and high pressure laminate.

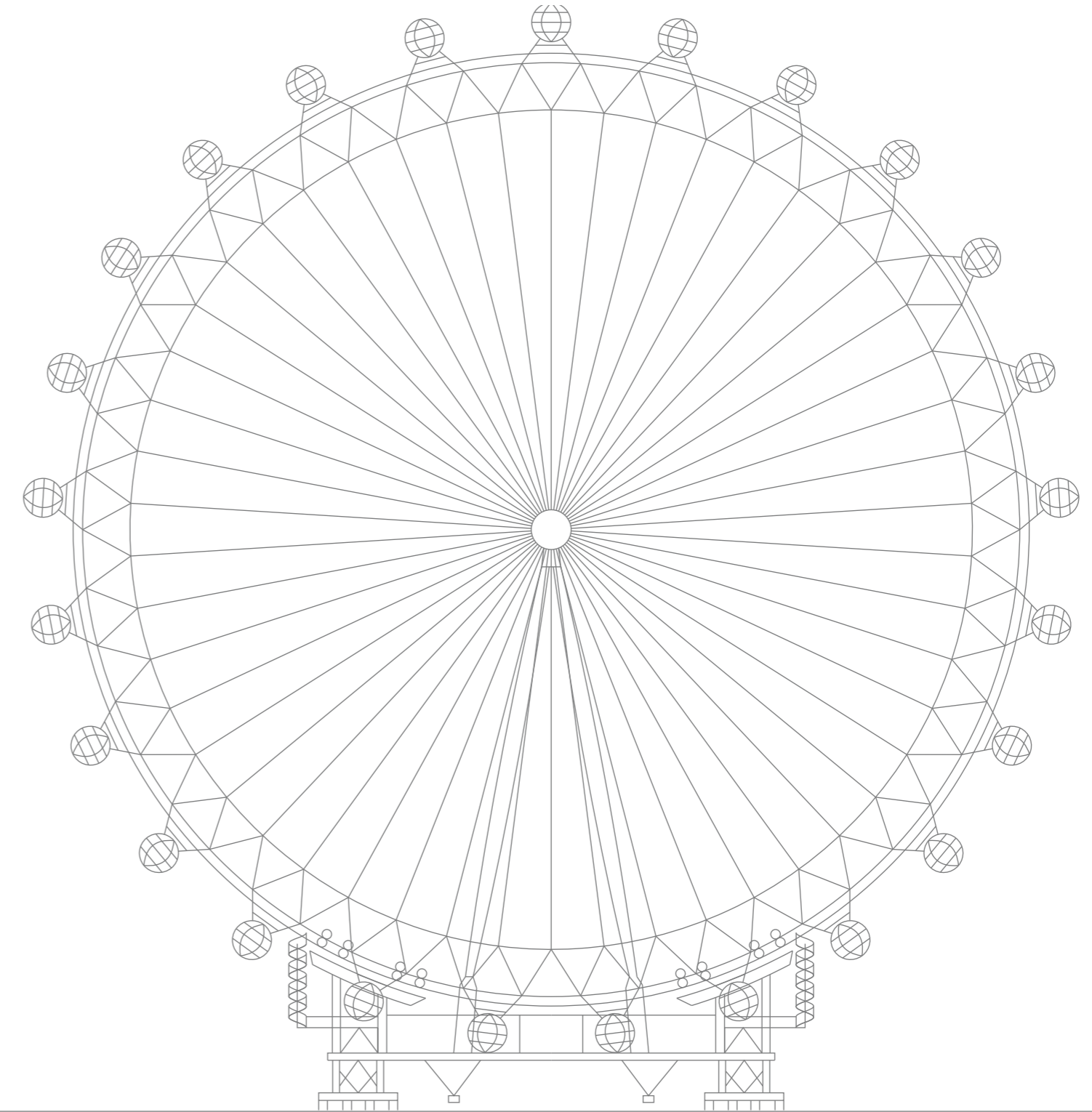

As seen at the London Eye.

oasis



oasis in high pressure laminate slab in solid surface

# oasis

## Features:

Visible full aluminium frame.  
Standard height of 2000mm with 150mm floor gap.  
Available in certain finishes in full height version up to 2700mm with minimal floor gap.  
Anti-fingertrap.  
Lock locates into integral receiver.  
Self-closing hydraulic door closer.  
Pivoted door.  
Stainless steel fittings.  
Machined stainless steel lock.  
Emergency release.  
10 year guarantee.

## Available in:

- Oasis Smart
- Glass
- Wood Veneer
- Stainless Steel
- Aluminium
- Compact Grade Laminate
- High Pressure Laminate

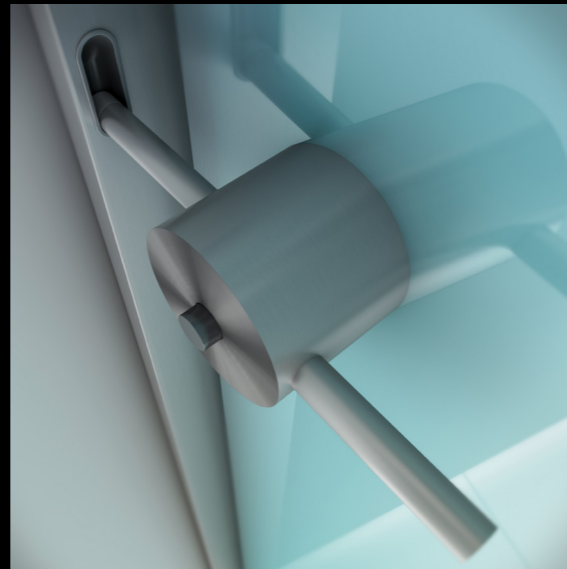

oasis surfaces and finishes			k32	
material	options	examples	Specification: Overall standard cubicle height 2000mm with 150mm floor clearance. Full height version available up to 2700mm tall with a 15mm floor gap.	Framework: Full aluminium frame. Extruded satin anodised headrail and vertical posts, with integral full height door closing buffer.
<p><b>glass</b></p> <p>Toughened glass, laminated or back painted to specified level of obscurity.</p>	<ul style="list-style-type: none"> <li>● Smart glass</li> <li>● Laminated glass</li> <li>● Low-Iron</li> <li>● Clear</li> <li>● Range of standard colours</li> <li>● RAL colour match on request</li> </ul>		<p>Door: 10mm back painted toughened glass or 10.76mm toughened laminated glass, polished to all edges. Countersunk stainless steel pig-nose fixings to the face of the door allow attachment to stainless steel pivot blocks. Door suspended from aluminium headrail and located onto bottom pivot bracket, falls closed by means of a hydraulic closer concealed within the aluminium headrail (alternatively, the closer can be factory set to fall open).</p> <p>Divider: 10mm back painted toughened glass or 10.76mm toughened laminated glass, polished to all edges. Supported 150mm from the floor by an engineered 304 grade stainless steel foot, with height adjustment.</p>	<p>Fittings: Engineered 303 grade brushed stainless steel lock, fixed through the door to the face plate for added strength. Lock finger housed within the door, extends from the door edge and engages into the receiver, integral to the aluminium framework. Complete with emergency release facility and buffer. Divider fixed to back wall using concealed steel brackets, fastened by through-fixings. Stainless steel coat hook supplied as standard.</p>
<p><b>wood veneer</b></p> <p>Real wood veneer backed with composite material to enable fabrication.</p>	<ul style="list-style-type: none"> <li>● Matt</li> <li>● Silk</li> <li>● Relief</li> <li>● Grained</li> <li>● Unfinished</li> <li>● Optional cross grain</li> </ul>		<p>Door: 32mm finished thickness consisting of a 30mm composite core, edged first and faced with wood veneer. Concealed fixings within the door allow attachment to dovetail pivot block. Door suspended from aluminium headrail and located onto a bottom pivot bracket, falls closed by means of a hydraulic closer concealed within the aluminium headrail (alternatively, the closer can be factory set to fall open). Complete with anti-finger trap clearance on pivot side of door.</p> <p>Divider: 18mm finished thickness consisting of a 16mm moisture resistant chipboard core, lip-edged first to top and bottom edges, then faced with wood veneer. Supported 150mm from the floor by an engineered 304 grade stainless steel foot, with height adjustment.</p>	
<p><b>metallic</b></p> <p>Metallic sheet bonded to MDF core, double folded on vertical edges.</p>	<ul style="list-style-type: none"> <li>● Brushed stainless steel</li> <li>● Patterned stainless steel</li> <li>● Satin anodised aluminium</li> <li>● Powder coated aluminium</li> </ul>		<p>Door: 32mm finished thickness consisting of a 30mm composite core, edged top and bottom in matching high pressure laminate, then faced both sides with stainless steel sheet, each double folded to create vertical seam in the centre of the door edge. Concealed fixings within the door allow attachment to dovetail pivot block. Suspended from aluminium headrail and located onto a bottom pivot bracket, door falls closed by means of a hydraulic closer concealed within the aluminium headrail. Anti-finger trap clearance on pivot side of door.</p> <p>Divider: 18mm finished thickness consisting of a 16mm moisture resistant chipboard core, faced both sides with stainless steel sheet, each folded to create a horizontal seam in the centre of the divider edge. Supported 150mm from the floor by an engineered 304 grade stainless steel foot, with height adjustment.</p>	
<p><b>laminate</b></p> <p>Multiple layers of resin-impregnated high quality kraft papers.</p>	<ul style="list-style-type: none"> <li>● Compact Grade Laminate</li> <li>● High Pressure Laminate</li> <li>● Extensive range of colours</li> <li>● Wide range of suppliers</li> <li>● Colour match on request</li> <li>● Wood grains</li> <li>● Digital prints</li> </ul>		<p>Door: 12mm compact grade laminate, polished to all edges. Stainless steel fixings to the face of the door allow attachment to stainless steel pivot blocks. Door suspended from aluminium headrail and located onto bottom pivot bracket, falls closed by means of a hydraulic closer concealed within the aluminium headrail (alternatively, the closer can be factory set to fall open).</p> <p>Divider: 12mm compact grade laminate, polished to visible edges. Supported 150mm from the floor by an engineered 304 grade stainless steel foot, with height adjustment.</p>	



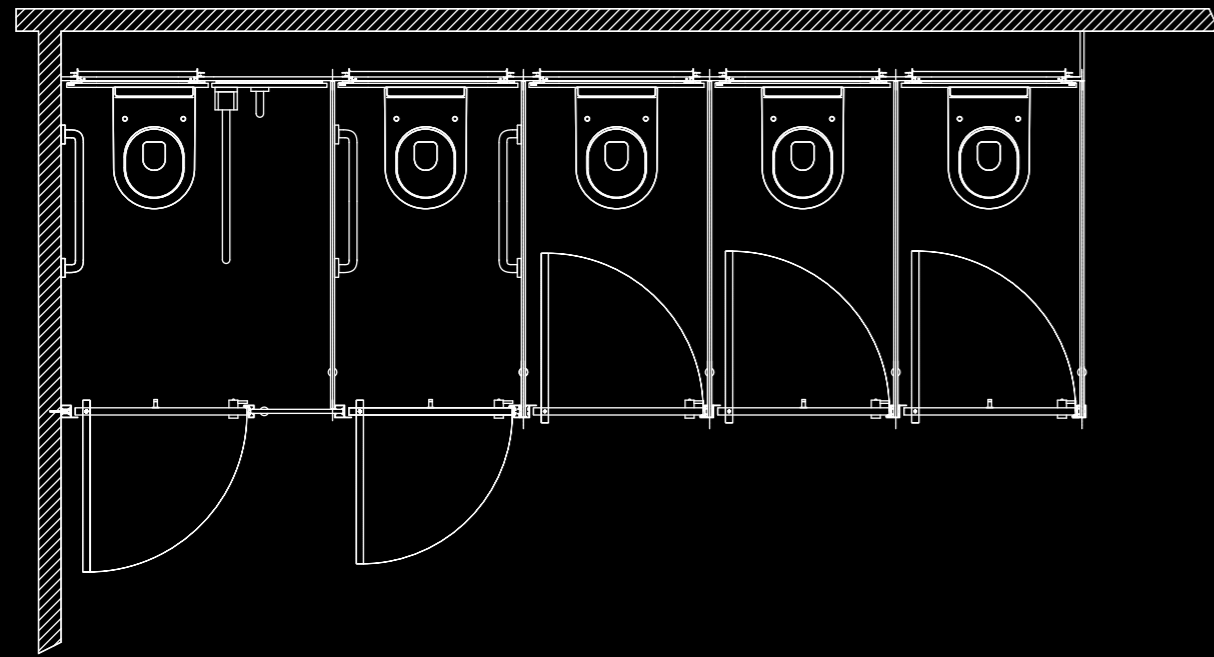

**typical layout**

Shown as a run of five in a corner, with Sentry access panels, one open-out disabled cubicle and one open-out ambulant cubicle.

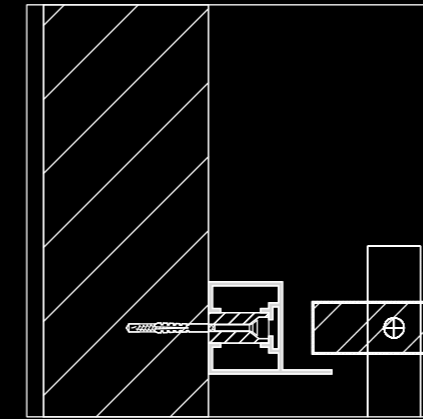
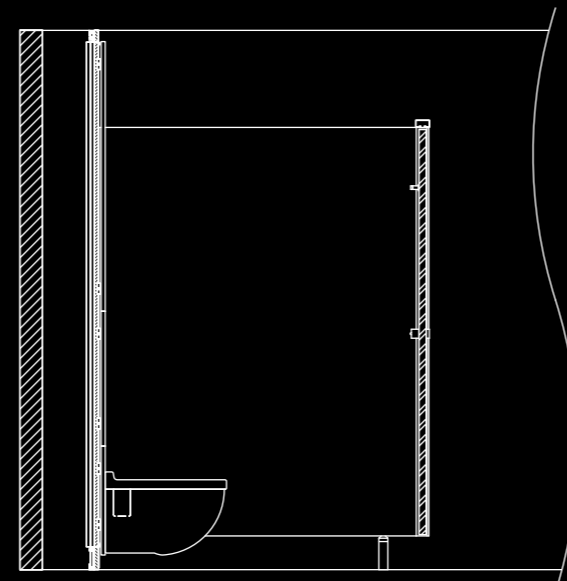
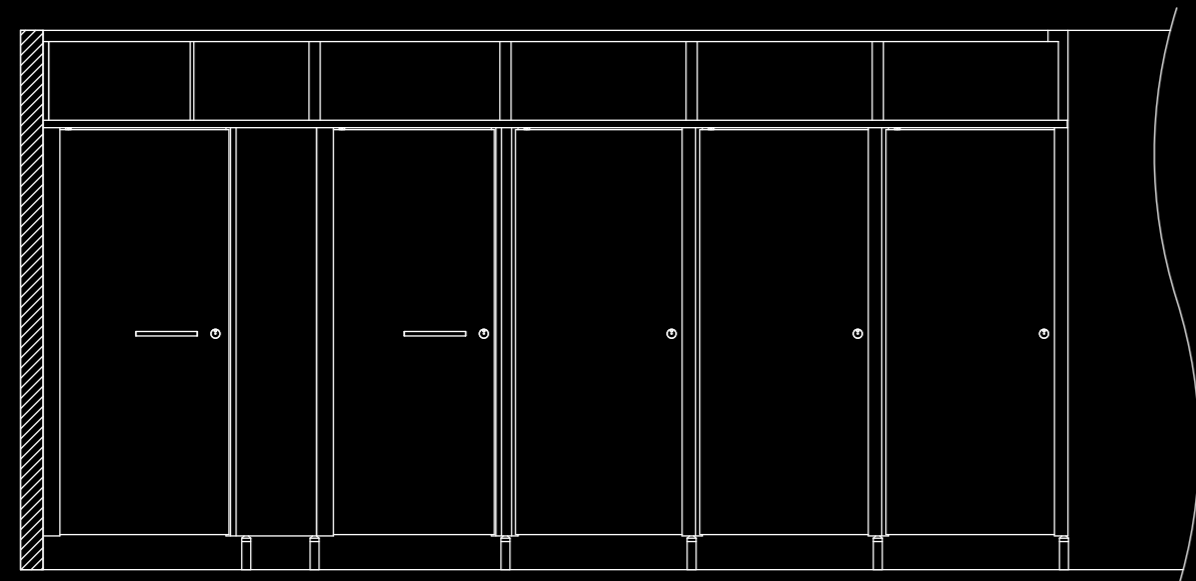

Detail 1

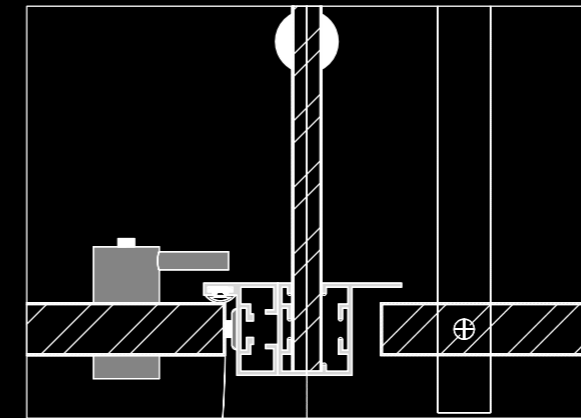

Detail 2

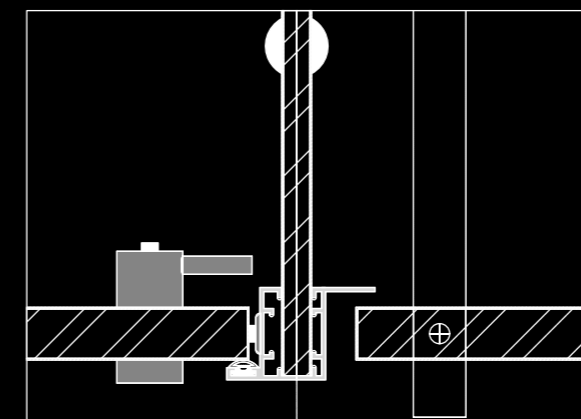

Detail 3

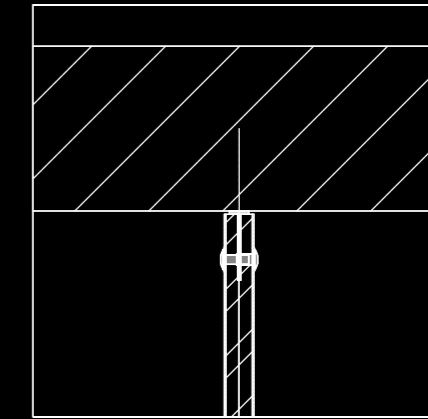

Detail 4

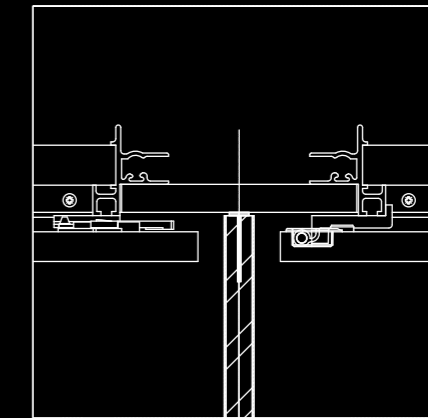

Detail 5

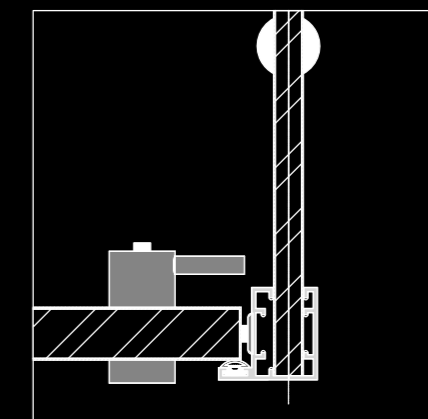

Detail 6



thrislington cubicles

Product: Oasis

Layout: Common details are shown, but the system is designed to be as adaptable as possible, and will fit almost any layout.

Detail 1: Wall Hinge Outward Post

Detail 2: Centre Close Outward / Hinge Inward Assembly

Detail 3: Centre Hinge Inward / Close Inward Post

Detail 4: Divider to Bracket Fixing Against a Wall

Detail 5: Divider to Bracket Fixing Against a Sentry Infill

Detail 6: Corner Close Inward Post

As seen in Oslo Opera House.

A perfect marriage of elegance and smart thinking, Icon's clean lines are only made possible through its intelligent details, which include engineered aluminium fittings and self closing 27mm thick doors.

Available in glass, wood veneer, stainless steel, aluminium, compact grade and high pressure laminate.

**icon**

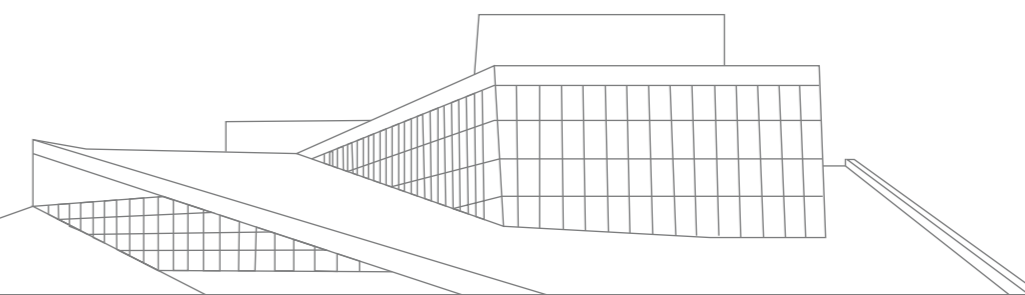

icon



icon in brushed aluminium sentry in glass slab in solid surface

#### Features:

Visible full aluminium frame.  
Standard height of 2000mm with 150mm floor gap.  
Available in certain finishes in full height version up to 2500mm with 100mm floor gap.  
Anti-fingertrap.  
Machined aluminium lock locates into post.  
Concealed self-closing door closer in foot.  
Pivoted door.  
Aluminium fittings.  
Emergency release.  
10 year guarantee.

#### Available in:

- Glass
- Wood Veneer
- Stainless Steel
- Aluminium
- Compact Grade Laminate
- High Pressure Laminate

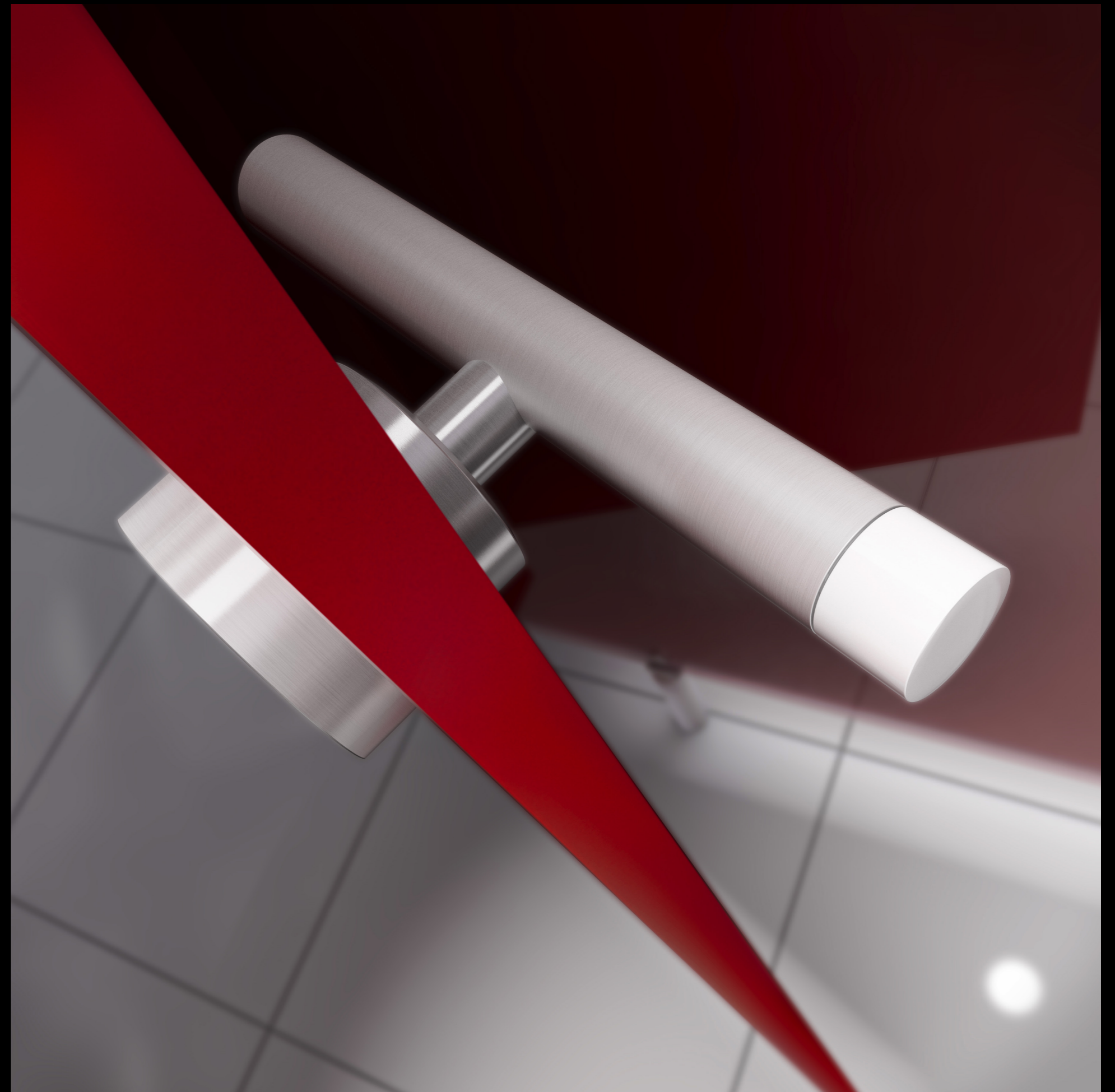

icon surfaces and finishes			k32									
material	options	examples	<p><b>Specification:</b> Overall standard cubicle height 2000mm with 150mm floor clearance. Full height version available up to 2500mm tall with a 100mm floor gap.</p> <p><b>Framework:</b> Full anodised aluminium frame, with extruded headrail and vertical posts. Lock locates directly into vertical closing post, incorporating full length buffer.</p>									
<p><b>glass</b></p> <p>Toughened glass, laminated or back painted to specified level of obscurity.</p>	<ul style="list-style-type: none"> <li>● Laminated glass</li> <li>● Low-Iron</li> <li>● Clear</li> <li>● Range of standard colours</li> <li>● RAL colour match on request</li> </ul>		<p><b>Door:</b> 10mm back painted toughened glass or 10.76mm toughened laminated glass, polished to all edges. Flush aluminium studs secured through the door to the pivot brackets, allow the door to pivot between aluminium headrail and engineered aluminium foot. Foot incorporates height adjustment and sealed bearing providing self-closing mechanism (alternatively, the mechanism can be factory set to fall open). Complete with anti-finger trap clearance on pivot side of door.</p> <p><b>Divider:</b> 10mm back painted toughened glass or 10.76mm toughened laminated glass, polished to all edges. Supported 150mm from the floor by an engineered anodised aluminium foot, with height adjustment.</p>									
<p><b>wood veneer</b></p> <p>Real wood veneer backed with composite material to enable fabrication.</p>	<ul style="list-style-type: none"> <li>● Matt</li> <li>● Silk</li> <li>● Relief</li> <li>● Grained</li> <li>● Unfinished</li> <li>● Optional cross grain</li> </ul>		<p><b>Door:</b> 27mm finished thickness consisting of a 25mm moisture resistant chipboard core, edged first and faced with wood veneer. Flush aluminium studs secured through the door to the pivot brackets, allow the door to pivot between aluminium headrail and engineered aluminium foot. Foot incorporates height adjustment and sealed bearing providing self-closing mechanism (alternatively, the mechanism can be factory set to fall open). Complete with anti-finger trap clearance on pivot side of door.</p> <p><b>Divider:</b> 17mm finished thickness consisting of a 15mm moisture resistant chipboard core, lip-edged first to visible edges, then faced with wood veneer. Supported 150mm from the floor by an engineered anodised aluminium foot, with height adjustment.</p>									
<p><b>metallic</b></p> <p>Metallic sheet bonded to MDF core, double folded on vertical edges.</p>	<ul style="list-style-type: none"> <li>● Brushed stainless steel</li> <li>● Patterned stainless steel</li> <li>● Satin anodised aluminium</li> <li>● Powder coated aluminium</li> </ul>		<p><b>Door:</b> 27mm finished thickness consisting of a 25mm moisture resistant chipboard core, edged top and bottom in matching high pressure laminate, then faced both sides with aluminium sheet, each double folded to create vertical seam in the centre of the door edge. Flush aluminium studs secured through the door to the pivot brackets, allow the door to pivot between aluminium headrail and engineered aluminium foot. Foot incorporates height adjustment and sealed bearing providing self-closing mechanism (alternatively, the mechanism can be factory set to fall open). Complete with anti-finger trap clearance on pivot side of door.</p> <p><b>Divider:</b> 17mm finished thickness consisting of a 15mm moisture resistant chipboard core, lip-edged first to visible edges with a matching high pressure laminate, then faced with aluminium sheet. Supported 150mm from the floor by an engineered anodised aluminium foot, with height adjustment.</p>									
<p><b>laminate</b></p> <p>Multiple layers of resin-impregnated high quality kraft papers.</p>	<ul style="list-style-type: none"> <li>● Compact Grade Laminate</li> <li>● High Pressure Laminate</li> <li>● Extensive range of colours</li> <li>● Wide range of suppliers</li> <li>● Colour match on request</li> <li>● Wood grains</li> <li>● Digital prints</li> </ul>		<p><b>Door:</b> 12mm compact grade laminate, polished to all edges. Flush aluminium studs secured through the door to the pivot brackets, allow the door to pivot between aluminium headrail and engineered aluminium foot. Foot incorporates height adjustment and sealed bearing providing self-closing mechanism (alternatively, the mechanism can be factory set to fall open). Complete with anti-finger trap clearance on pivot side of door.</p> <p><b>Divider:</b> 12mm compact grade laminate, polished to visible edges. Supported 150mm from the floor by an engineered anodised aluminium foot, with height adjustment.</p>									

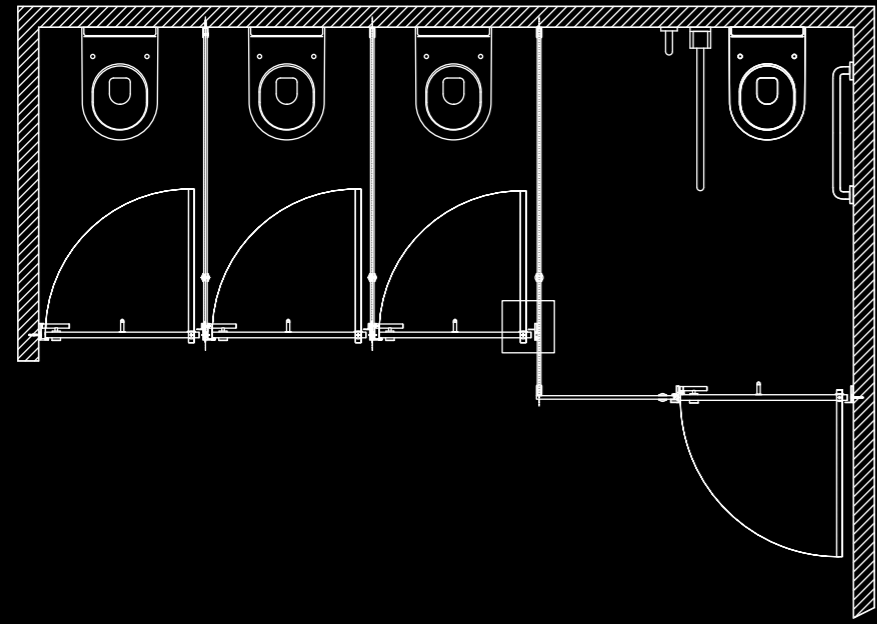

**typical layout**

As shown as a run of four with one large stepped out disabled cubicle.

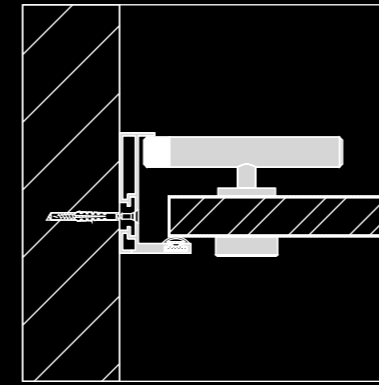
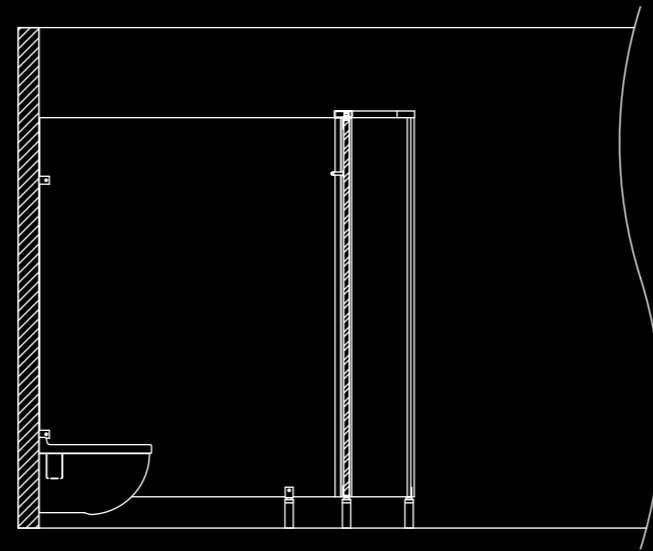
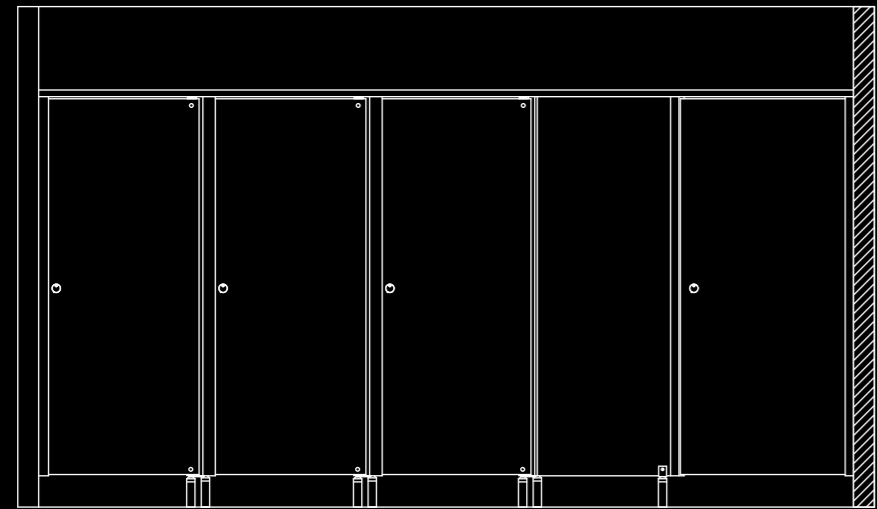

Detail 1

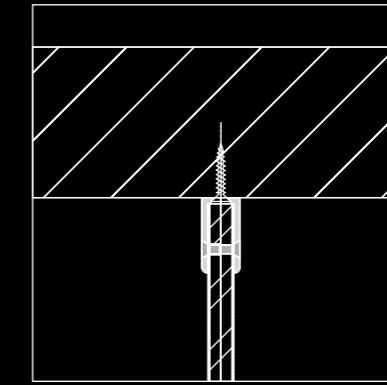

Detail 4

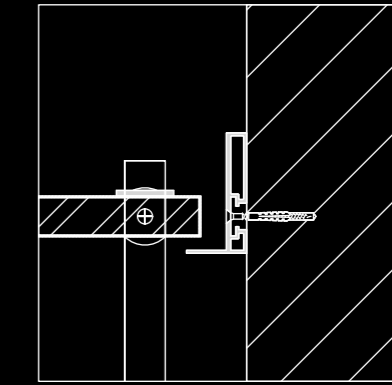

Detail 6

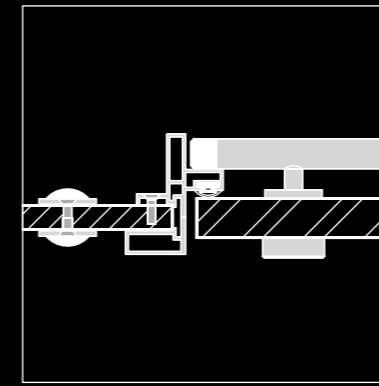

Detail 2

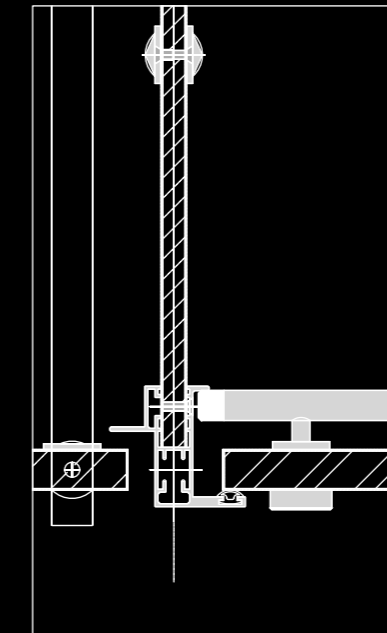

Detail 5

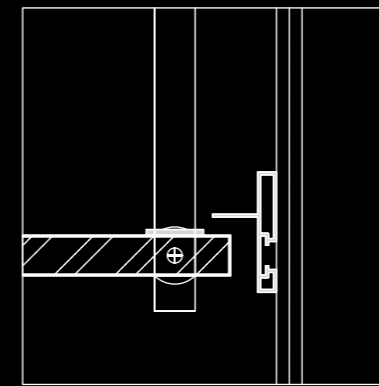

Detail 3



thrislington cubicles

Product: Icon

Layout: Common details are shown, but the system is designed to be as adaptable as possible, and will fit almost any layout.

Detail 1: Wall Close Inward Post

Detail 2: Fascia Close Outward Post

Detail 3: Wall Hinge Inward Post (Fitted to divider panel)

Detail 4: Divider to Bracket Fixing

Detail 5: Centre Hinge Inward / Close Inward Post

Detail 6: Wall Hinge Outward Post

As seen in Denstone College,

polo

Value engineered perfection. Our most cost effective cubicle still has the standard Thrislington features that other cubicles in its price range can only dream about.

Available in compact grade and high pressure laminate.



polo



polo in compact grade laminate sentry in compact grade laminate fusion in compact grade laminate



polo

Features:

Visible powder coated aluminium frame.  
Standard height of 2000mm with 150mm floor gap.  
Available in full height version up to 2400mm with 28mm floor gap.  
Anti-fingertrap.  
Machined painted aluminium lock locates into post.  
Rise and fall self-closing door mechanism located in foot.  
Pivoted door.  
Powder coated aluminium fittings.  
Emergency release.  
10 year guarantee.

Available in:

- Compact Grade Laminate
- High Pressure Laminate

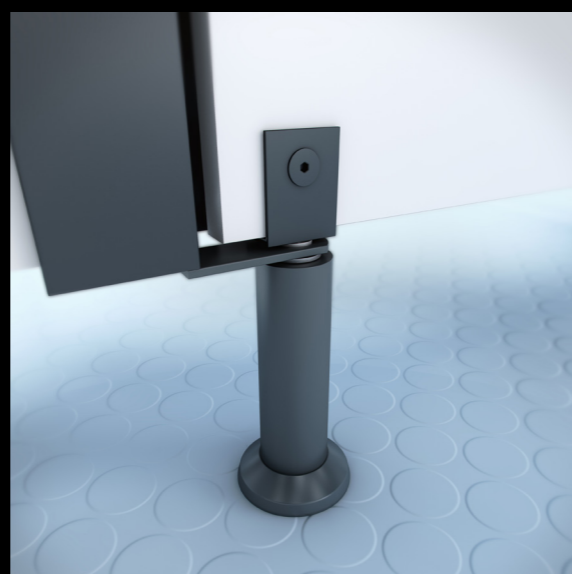

polo surfaces and finishes			k32	
material	options	examples	Specification: Overall cubicle height 2000mm with 150mm floor clearance. Full height version available up to 2400mm with a 28mm floor gap.	Fittings: Painted aluminium lock, fixed through the door to the face plate for added strength. Sacrificial hard nylon shear tip to the lock finger, which locates directly into the vertical closing post. Complete with emergency release facility. Divider fixed to back wall using extruded powder coated aluminium brackets secured using through-fixings. Powder coated aluminium coat hook supplied as standard.
<p><b>laminate</b></p> <p>Multiple layers of resin-impregnated high quality kraft papers.</p>	<ul style="list-style-type: none"> <li>● Compact Grade Laminate</li> <li>● High Pressure Laminate</li> <li>● Extensive range of colours</li> <li>● Wide range of suppliers</li> <li>● Colour match on request</li> <li>● Wood grains</li> <li>● Digital prints</li> </ul>		<p>Framework: Full powder coated aluminium frame in specified finish, including extruded aluminium headrail and vertical posts. Lock locates directly into vertical closing post, including buffers.</p>	<p><b>Door:</b> 19mm finished thickness consisting of 17mm moisture resistant chipboard core, faced with High Pressure Laminate and edged all round with 2mm PVC/ABS tape to match framework finish. Extruded through-fixed aluminium brackets allow the door to pivot between aluminium headrail and floor fixed foot. Foot incorporates a rise and fall closing mechanism and includes height adjustment. Complete with anti-finger trap clearance on pivot side of door.</p> <p><b>Divider:</b> 19mm finished thickness consisting of 17mm moisture resistant chipboard core, faced with High Pressure Laminate and finished to all visible edges with 2mm PVC/ABS tape to match framework finish. Supported 150mm from the floor by a powder coated aluminium foot, with height adjustment.</p>
<p><b>frame colour</b></p> <p>Powder coated aluminium framework with accessories to colour match.</p>	<ul style="list-style-type: none"> <li>● RAL 7011</li> <li>● RAL 7035</li> </ul>			

This is a small range of the extensive selection of the finishes available. All colours are representative. We recommend you ring for a sample.

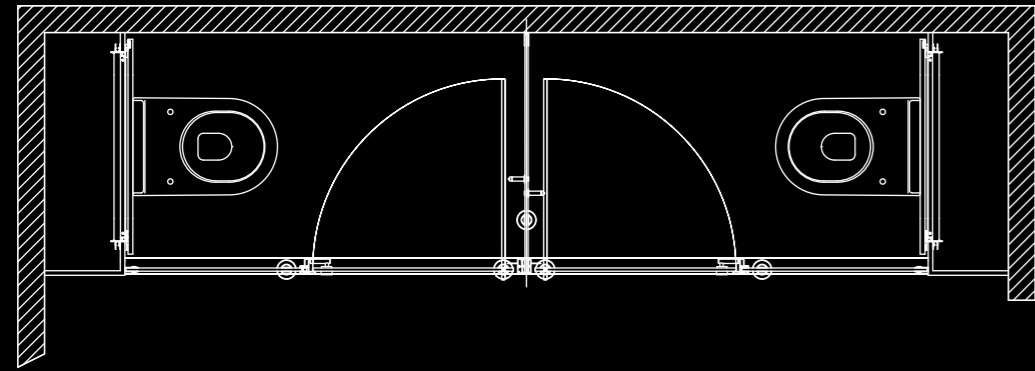

**typical layout**

Shown as two in-line cubicles.

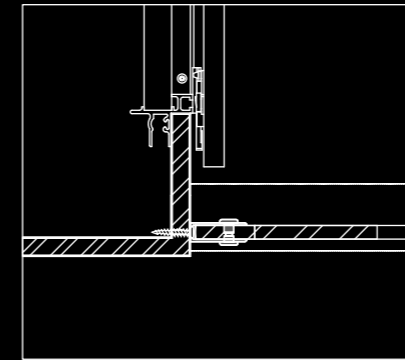
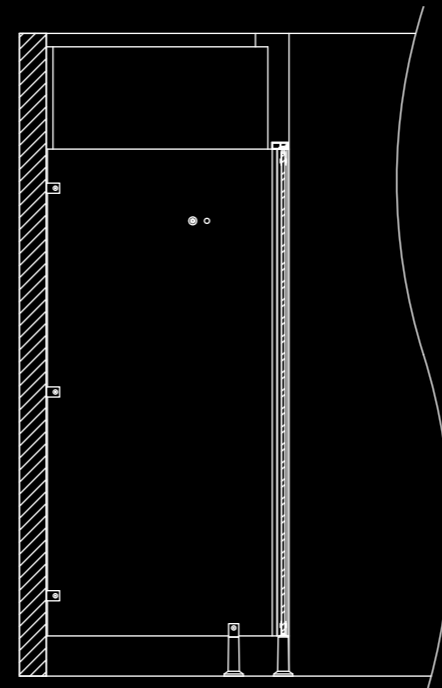
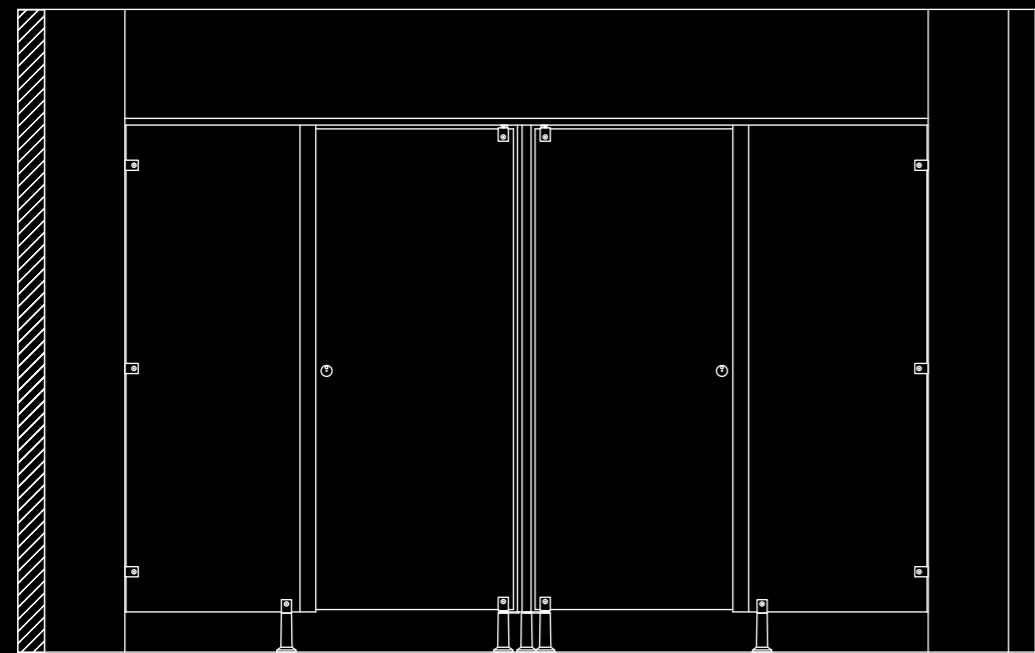

Detail 1

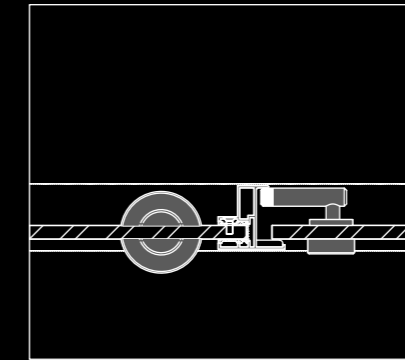

Detail 2

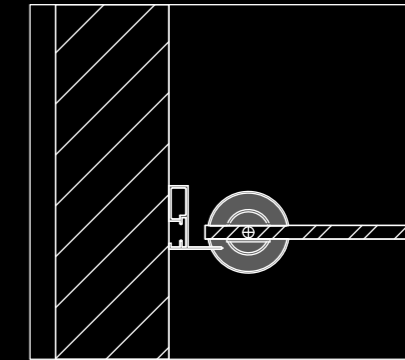

Detail 3

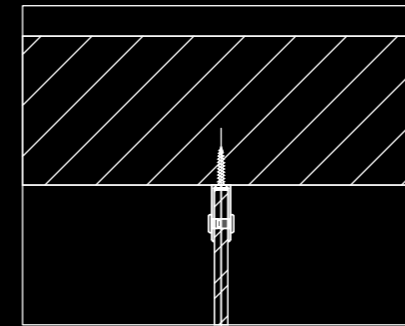

Detail 4

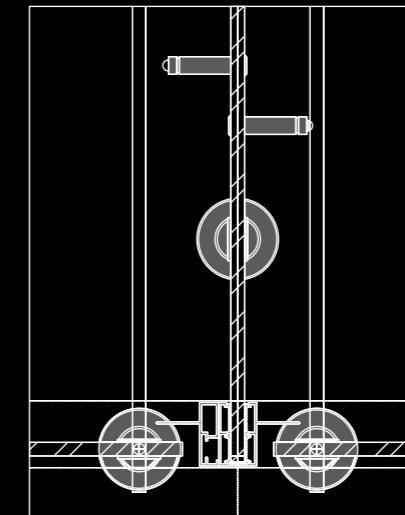

Detail 5

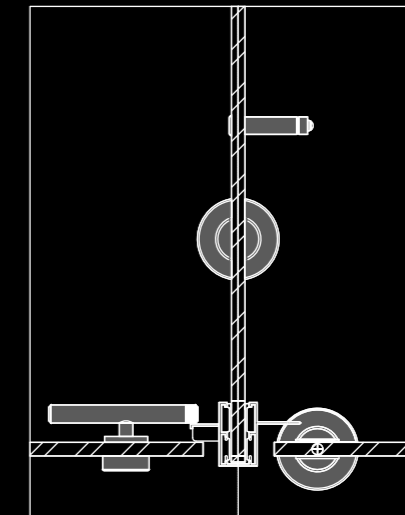

Detail 6



thrislington cubicles

Product: Polo

Layout: Common details are shown, but the system is designed to be as adaptable as possible, and will fit almost any layout.

Detail 1: Fascia bracket fixing to Sentry infill

Detail 2: Divider Bracket Fixing Against A Wall

Detail 3: Fascia Close Inward Post

Detail 4: Wall Hinge Inward / Corner Hinge Inward Assembly

Detail 5: Wall Hinge Outward Post (not shown on layout)

Detail 6: Centre Close Outward / Hinge Inward Post (not shown on layout)

As seen in Kings Cross St Pancras Station, London.

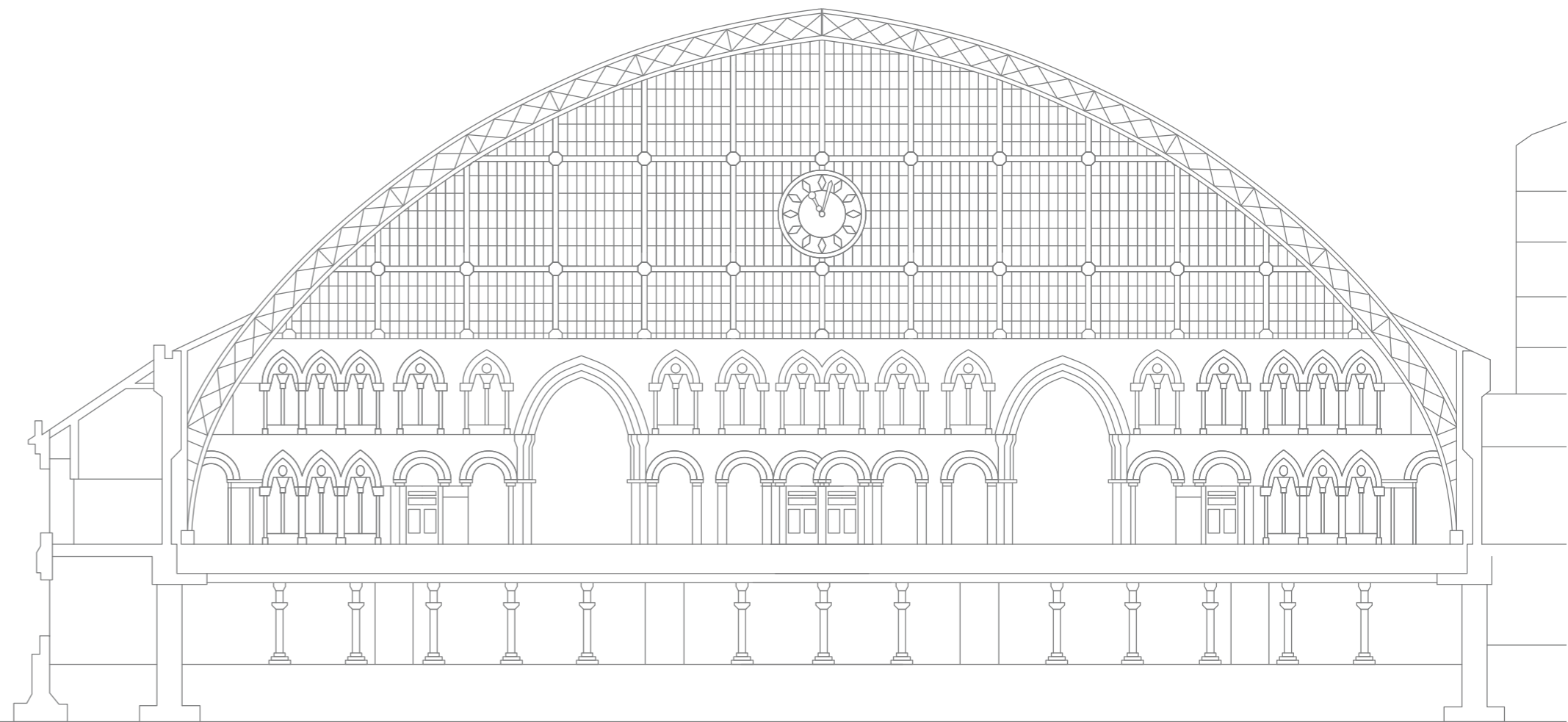

## sentry

The system that's elegant, with maintenance free access, but tough enough to withstand serious abuse.

Available in glass, wood veneer, stainless steel, aluminium, compact grade and high pressure laminate.

sentry



sentry in stainless steel flow in stainless steel slab in solid surface urinal screen in compact grade laminate

# sentry

**Features:**

Full aluminium framework.  
Factory prefabricated access panel system.  
Up to 3000mm high.  
Available for toilet pans, urinals, wash-hand basins or simply wall panelling.  
Hinged access doors fastened by concealed catches.  
10 year guarantee.

**Available in:**

- Glass
- Wood Veneer
- Stainless Steel
- Aluminium
- Compact Grade Laminate
- High Pressure Laminate



sentry surfaces and finishes			k32	
material	options	examples	Specification: Fully pre-fabricated hinged access panel module up to 3000mm high. Overall depth from the rear of the framework to front face of panel is 87mm. The system is not designed to prevent water penetration. In a shower situation, we would recommend the use of sentry with Compact Grade Laminate panels.	
<p><b>glass</b></p> <p>Toughened back painted glass.</p>	<ul style="list-style-type: none"> <li>● Low-Iron</li> <li>● Clear</li> <li>● Range of standard colours</li> <li>● RAL match on request</li> </ul>		<p>Framework: Full aluminium frame, factory assembled using extruded vertical posts and horizontal cross rails, manufactured to bespoke width and height and supported by zinc-plated mild steel adjustable feet. Frame locates into floor and ceiling channel and is braced to the back wall with aluminium angle, to a specified distance (standard is 300mm to the face of the panels). This framework fully supports the module and no other framework needs to be in place to enable the fitting of the system.</p>	
<p><b>wood veneer</b></p> <p>Real wood veneer backed with composite material to enable fabrication.</p>	<ul style="list-style-type: none"> <li>● Matt</li> <li>● Silk</li> <li>● Relief</li> <li>● Grained</li> <li>● Unfinished</li> <li>● Optional cross grain</li> </ul>		<p>Access Panels: 22mm finished thickness consisting of 15mm moisture resistant chipboard/MDF core, finished on both faces with matching High Pressure Laminate, then edged with matching PVC/ABS tape, to accept a 5mm back painted toughened glass panel to front face. The standard configuration allows for 3 no panels per module, although this can be varied to suit a particular application. The size and positioning of all cut-outs for the sanitary ware and any other accessories, need to be confirmed by others, prior to the fabrication of the glass panels.</p>	
<p><b>metallic</b></p> <p>Metallic sheet bonded to MDF core, folded on vertical edges.</p>	<ul style="list-style-type: none"> <li>● Brushed stainless steel</li> <li>● Patterned stainless steel</li> <li>● Satin anodised aluminium</li> <li>● Powder coated aluminium</li> </ul>		<p>Access Panels: 17mm finished thickness consisting of a 15mm moisture resistant chipboard/MDF core. Panels are edged first and then faced with wood veneer, with balancing backing laminate. The standard configuration allows for 3 panels per module, although this can be varied to suit a particular application. Cut-outs for the sanitary ware are undertaken on site, to allow for flexibility/tolerance. Additional cut-outs for other accessories are possible.</p>	
<p><b>laminate</b></p> <p>Multiple layers of resin-impregnated high quality kraft papers.</p>	<ul style="list-style-type: none"> <li>● Compact Grade Laminate</li> <li>● High Pressure Laminate</li> <li>● Extensive range of colours</li> <li>● Wide range of suppliers</li> <li>● Colour match on request</li> <li>● Wood grains</li> <li>● Digital prints</li> </ul>		<p>Access Panels: 17mm finished thickness consisting of a 15mm moisture resistant chipboard/MDF core. Panels are finished on top and bottom edges in a matching High Pressure Laminate and then faced with stainless steel sheet, folded around vertical edges. The panel is balanced with backing laminate. The standard configuration allows for 3 panels per module, although this can be varied to suit a particular application. Cut-outs for the sanitary ware are undertaken on site, to allow for flexibility/tolerance. Additional cut-outs for other accessories are possible.</p>	
			<p>Access Panels: 17mm finished thickness consisting of a 15mm moisture resistant chipboard/MDF core. Where vertical edges are square, the panels are edged first and then faced with High Pressure Laminate, with balancing backing laminate. Alternatively, vertical edges can be postformed. The standard configuration allows for 3 panels per module, although this can be varied to suit a particular application. Cut-outs for the sanitary ware are undertaken on site, to allow for flexibility/tolerance. Additional cut-outs for other accessories are possible.</p>	

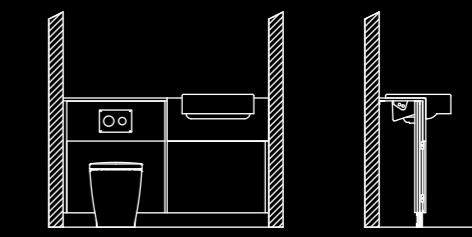
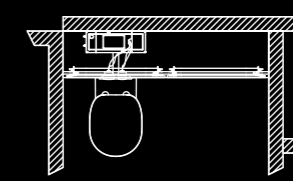
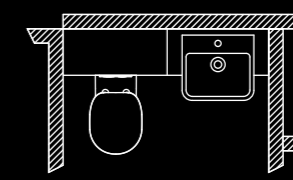
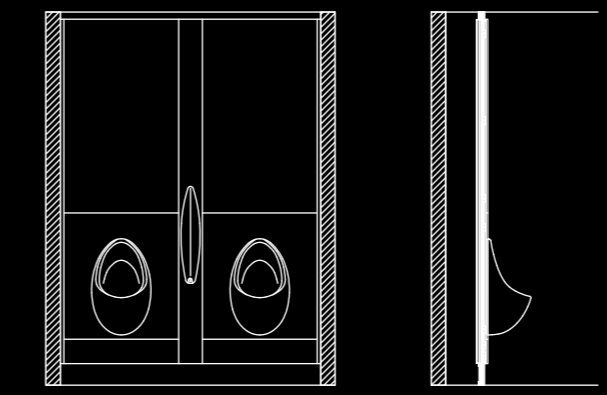
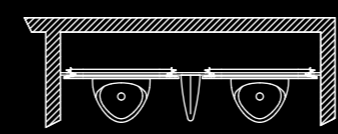
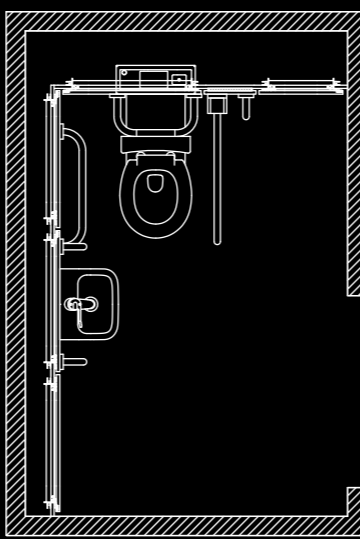
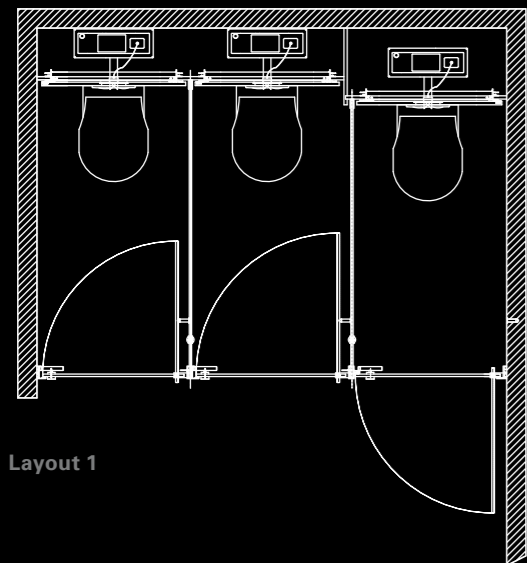
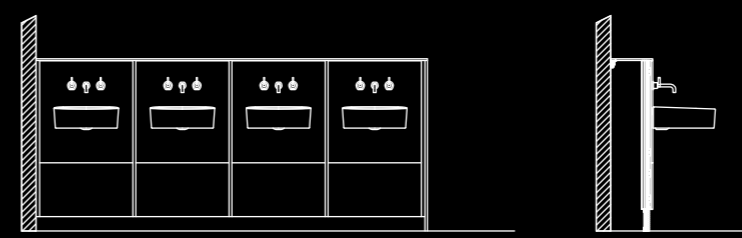
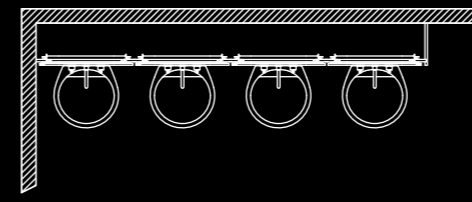
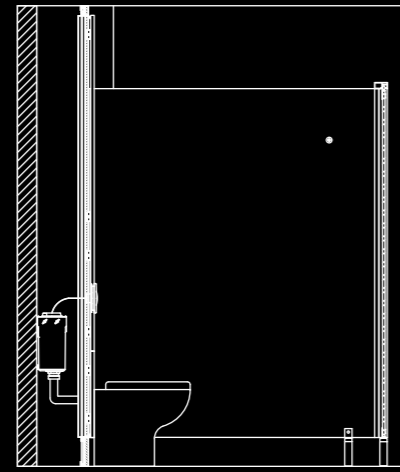
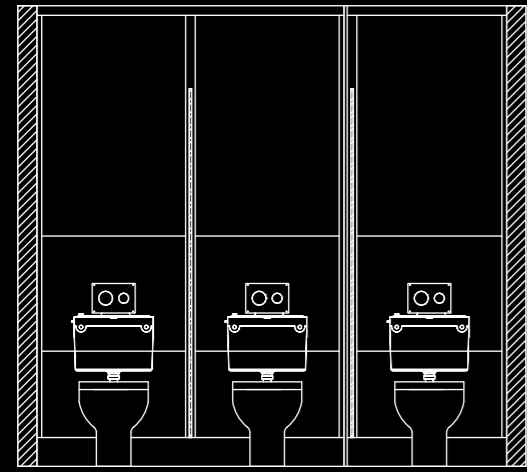

Layout 1

Layout 3

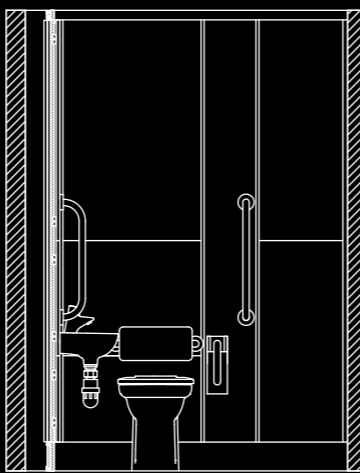
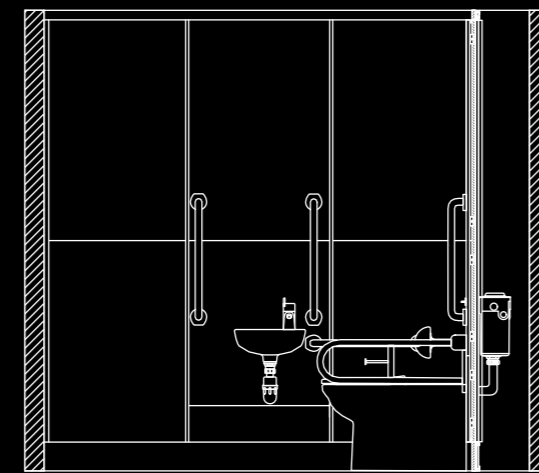

Layout 4

Layout 2

Layout 5



thrislington cubicles

Product: Sentry

Layout: Common details are shown, but the system is designed to be as adaptable as possible, and will fit almost any layout.

Layout 1: Stepped Sentry between walls incorporating a return end.

Layout 2: Typical L-Shaped Accessible WC Sentry layout.

Layout 3: Low height Sentry with lid incorporating wall mounted wash hand basins (basins supplied by others).

Layout 4: Sentry between walls with urinals and modesty screen.

Layout 5: Low height Sentry with lid and Vanity Unit configuration.

Not to scale



We offer a range of different vanity units ideal for any specification and all designed to match perfectly with the rest of our range.

Available in kiln fused glass, solid surface, concrete, and both compact grade and high pressure laminate.

## vanity units

As seen in the Aquatics Centre, London.

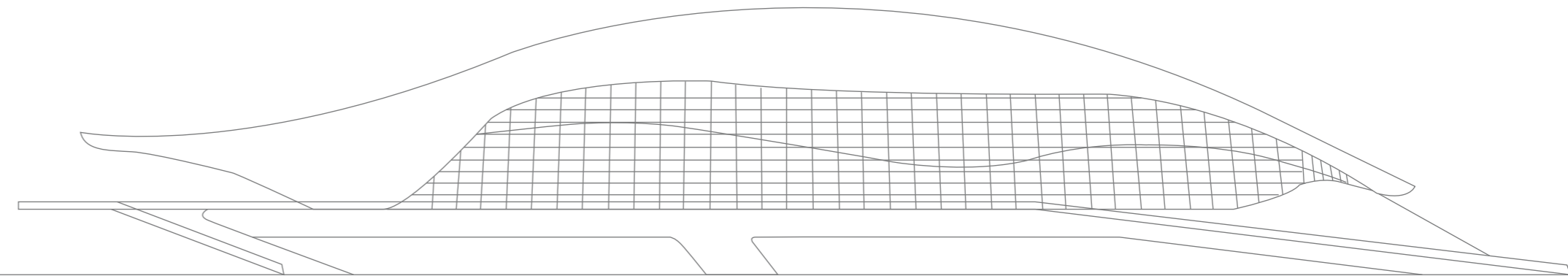

# vanity units



slab in solid surface with matching black bowls oasis and fusion in a high pressure laminate wood effect

# vanity units

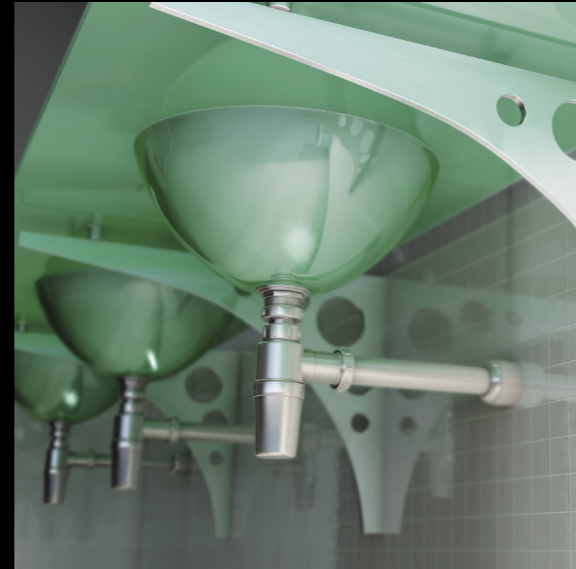

Features:  
Factory prefabricated.  
Variety of profiles.  
Optional access panels  
to conceal pipework.  
Supported by steel or  
aluminium framework.  
Available in a variety  
of designs.  
10 year guarantee.

Available in:  
● Glass  
● Granite  
● Concrete  
● Solid Surfaces  
● Compact Grade Laminate  
● High Pressure Laminate



slab in concrete

vanity units surfaces and finishes			k32
material	options	examples	
<p><b>glass</b></p> <p>Kiln fused safety glass.</p>	<ul style="list-style-type: none"> <li>● Clear glass</li> <li>● Low-Iron</li> <li>● Sandblasted or backpainted</li> <li>● Colour match on request</li> </ul>		<p><b>Specification:</b> Kiln fused 19mm toughened clear glass vanity top with integral glass bowl, sandblasted and finished with clearshield to protect the surface.</p> <p>Top can be supplied as clear or low-iron glass and can be back painted in a range of colours.</p> <p>Top can be supplied up to 2600mm in length, with a standard depth of 600mm and are normally installed 870mm from the finished floor level. Bowls to be 400mm in diameter (no overflow), drilled and rebated for waste with a depth of 150mm.</p> <p>Vanity top is supported by 8mm thick stainless steel bespoke cantilever brackets, with adjustable suction pad to underside of vanity top.</p>
<p><b>solid surface</b></p> <p>Fabricated and moulded to give seamless appearance.</p>	<ul style="list-style-type: none"> <li>● Extensive range of patterns</li> <li>● Range of solid colours</li> </ul>		<p><b>Specification:</b> Fabricated solid surface vanity top with standard downstand of 100mm. Can be supplied with an integrated solid surface bowl from a limited colour range, to create a seamless appearance.</p> <p>Alternatively, are able to accept under-mounted, surface mounted or counter-top wash hand basins (basins specified and supplied by others). Available at specified length and can be joined seamlessly on site.</p> <p>Standard depth is 600mm and tops are normally installed at a height of 870mm from finished floor level. These dimensions can be varied as required. As an option, a pre-fabricated vanity base with hinged panels can be supplied to sit underneath the top.</p>
<p><b>stone</b></p> <p>Solid stone polished and either moulded or cut.</p>	<ul style="list-style-type: none"> <li>● Granite</li> <li>● Concrete</li> </ul>		<p><b>Specification:</b> Concrete vanity top with standard downstand of 100mm, including integrated bowl. Able to accept under-mounted, surface mounted or counter-top wash hand basins (basins specified and supplied by others). Available up to a length of 2400mm with a standard depth of 600mm. Tops are normally installed at a height of 870mm from finished floor level. These dimensions can be varied as required. As an option, a pre-fabricated vanity base with hinged panels can be supplied to sit underneath the top.</p>
<p><b>laminate</b></p> <p>Multiple layers of resin-impregnated high quality kraft papers.</p>	<ul style="list-style-type: none"> <li>● High Pressure Laminate</li> <li>● Compact Grade Laminate</li> <li>● Extensive range of colours</li> <li>● Colour match on request</li> <li>● Digital prints</li> <li>● Wood grains</li> </ul>		<p><b>Specification:</b> Fully formed laminated vanity top with standard downstand of 100mm, postformed to leading edges, able to accept counter-top wash hand basin or surface mounted basin (basins specified and supplied by others). Available at specified length with joints required to suit sheet material and/or site accessibility. Where a joint is required, we would recommend that a solid surface vanity top is specified.</p> <p>Standard depth is 600mm and tops are normally installed at a height of 870mm from finished floor level. These dimensions can be varied as required. As an option, a pre-fabricated vanity base with hinged panels can be supplied to sit underneath the top.</p>

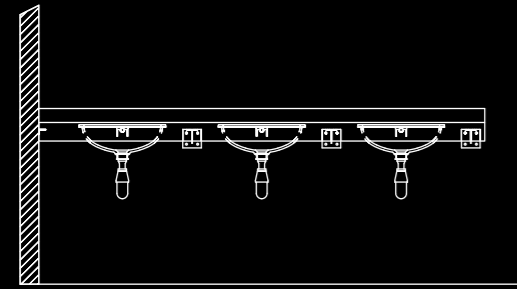
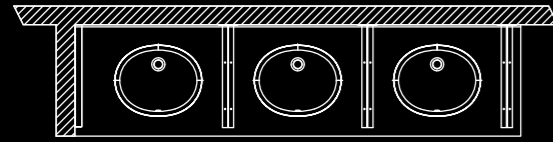

Layout 1

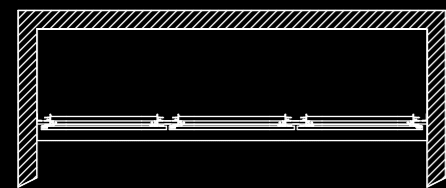
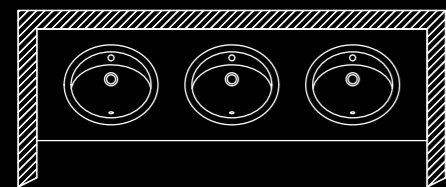

Layout 2

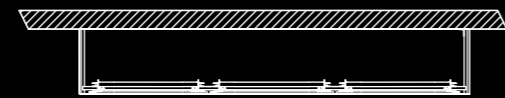
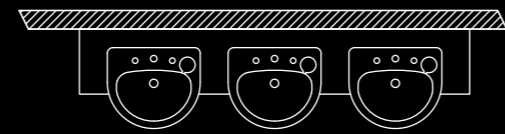
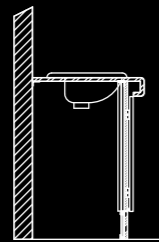

Layout 3

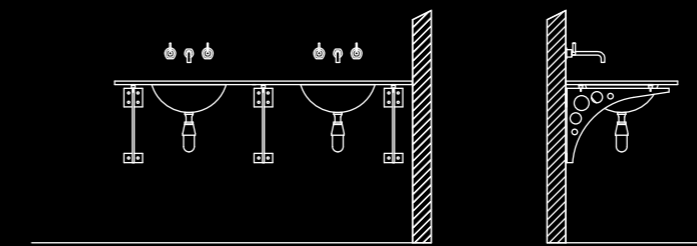
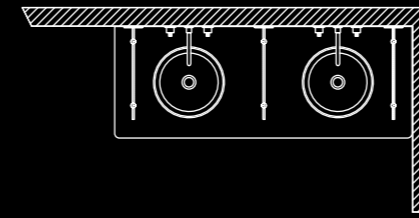
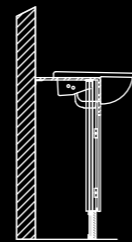
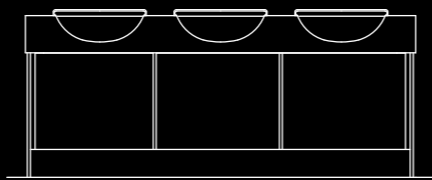

Layout 4

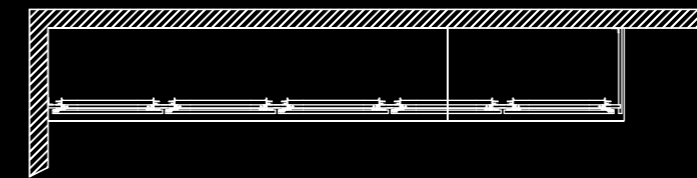

Layout 5

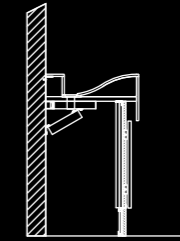

thrislington cubicles

Product: Vanity Units

Layout: Common details are shown, but the system is designed to be as adaptable as possible, and will fit almost any layout.

Layout 1: Slab vanity top in a corner supported on stainless steel cantilevered arms.

Layout 2: Slab vanity top between walls with base unit.

Layout 3: Freestanding Profile vanity top with base unit.

Layout 4: Kiln fused glass vanity top with integrated glass bowls, supported on stainless steel decorative brackets.

Layout 5: Jointed Trough in a corner with base unit.

# fusion

Fusion, our hard wearing locker system is designed for both wet and dry areas and is fully DDA compliant. Its intelligent anti-vandal features not only make it tough, but it also looks the part.

Available in fully bespoke sizes in glass, wood veneer, aluminium and compact grade laminate.

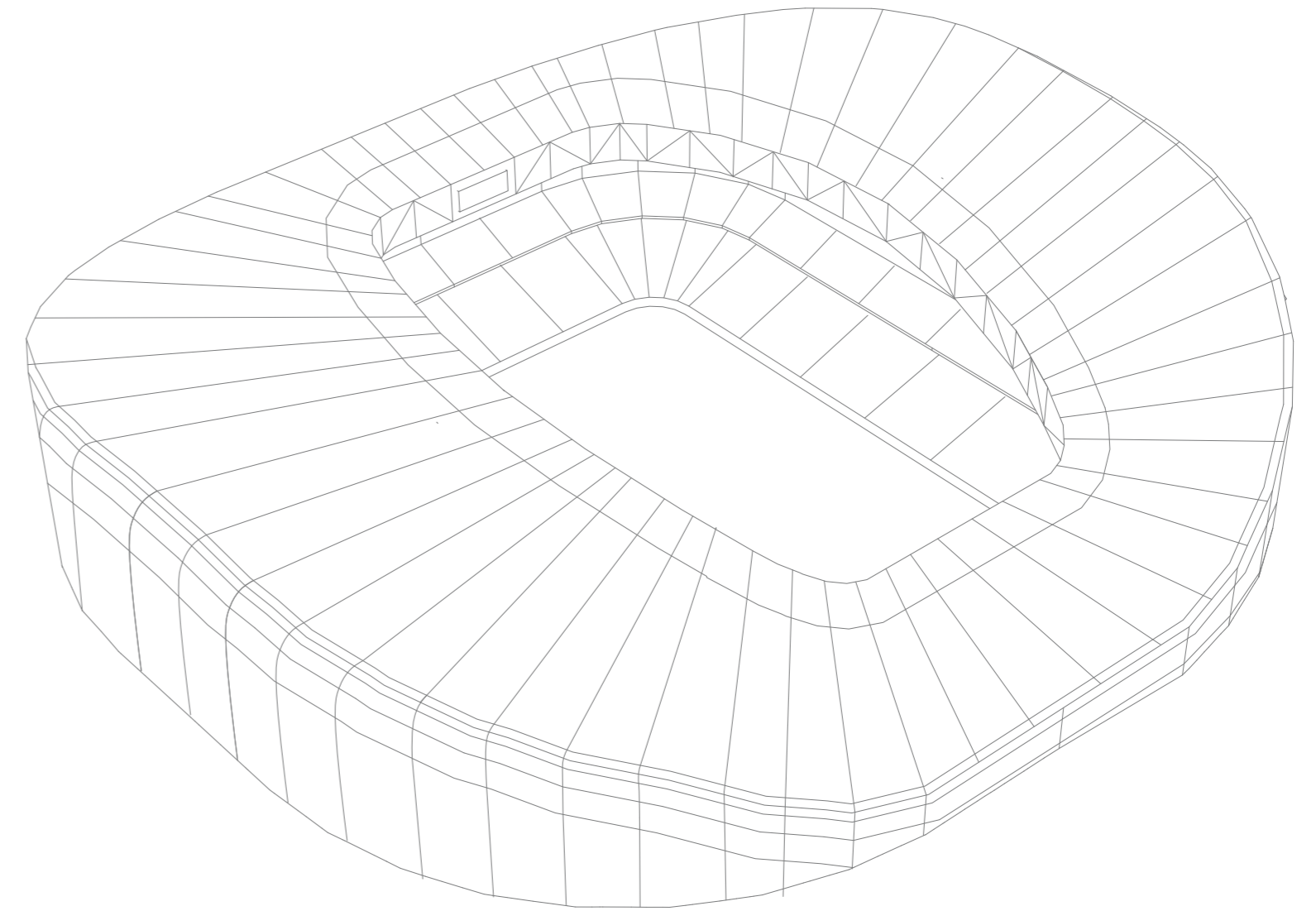

As seen in the Aviva Stadium, Dublin.

fusion



fusion in glass

# fusion

## Features:

Aluminium body.  
Standard height of 1800mm.  
Various configurations, including z-lockers.  
Variable depths and widths.  
Full extruded integral door frames and hinges.  
Large range of locking options.  
Designed for wet and humid conditions.  
Can work with a variety of different plinth options.  
10 year guarantee.

## Available in:

- Glass
- Wood Veneer
- Aluminium
- Compact Grade Laminate
- High Pressure Laminate





fusion surfaces and finishes			n10
material	options	examples	Specification: Fully assembled unit with aluminium locker body and door, supplied in a variety of height, width and depth combinations. Multiple lock options available.  Application: Suitable for use in both wet and dry areas and can be situated in a variety of layouts, such as to a back wall, as a free-standing unit, back to back in an island configuration, or fitted into a recess.
<p><b>glass</b></p> <p>Toughened back painted glass.</p>	<ul style="list-style-type: none"> <li>● Low-Iron</li> <li>● Clear</li> <li>● Range of standard colours</li> <li>● RAL match on request</li> </ul>		<p>Specification: Anodised aluminium studs on the outer face of the door, through-fixed into the continuous hinges for added strength, using stainless steel screws. As a standard, lockers are supplied with either hasp &amp; clasp or cam locks. Alternatives are coin operated, card operated or digital locks. Cam, coin operated and card operated locks are supplied with two keys and a tag, which can be numbered. Flexible PVC straps can be supplied. With the exception of digital locks, an anodised aluminium faceplate is provided, which also can be numbered.</p> <p>Door: 10mm back painted toughened glass, polished to all edges.</p> <p>Body: 1mm mill finished aluminium sheet body with a radius to the internal corners to reduce dirt traps and pre-drilled holes for site fixing. Continuous spring loaded hinges locate into extruded aluminium profiles. Where layout results in an exposed end, a return panel can be supplied in a finish to match the doors.</p>
<p><b>wood veneer</b></p> <p>Real wood veneer backed with composite material to enable fabrication.</p>	<ul style="list-style-type: none"> <li>● Matt</li> <li>● Silk</li> <li>● Relief</li> <li>● Grained</li> <li>● Unfinished</li> <li>● Optional cross grain</li> </ul>		<p>Door: 11mm finished thickness, consisting of 9mm plywood core, edged all round and then faced both sides in wood veneer.</p> <p>Body: 1mm mill finished aluminium sheet body with a radius to the internal corners to reduce dirt traps and pre-drilled holes for site fixing. Continuous spring loaded hinges locate into extruded aluminium profiles. Where layout results in an exposed end, a return panel can be supplied in a finish to match the doors.</p>
<p><b>metallic</b></p> <p>Aluminium sheet bonded to MDF core, edged in metallic laminate.</p>	<ul style="list-style-type: none"> <li>● Satin anodised aluminium</li> <li>● Powder coated aluminium</li> </ul>		<p>Door: 11mm finished thickness, consisting of 9mm plywood core, edged all round in a matching laminate and then faced both sides in sheet aluminium.</p> <p>Body: 1mm mill finished aluminium sheet body with a radius to the internal corners to reduce dirt traps and pre-drilled holes for site fixing. Continuous spring loaded hinges locate into extruded aluminium profiles. Where layout results in an exposed end, a return panel can be supplied in a finish to match the doors.</p>
<p><b>laminate</b></p> <p>Multiple layers of resin-impregnated high quality kraft papers.</p>	<ul style="list-style-type: none"> <li>● High Pressure Laminate</li> <li>● Compact Grade Laminate</li> <li>● Extensive range of colours</li> <li>● Colour match on request</li> <li>● Digital prints</li> <li>● Wood grains</li> </ul>		<p>Door: 12mm Compact Grade Laminate, polished to all edges.</p> <p>Body: 1mm mill finished aluminium sheet body with a radius to the internal corners to reduce dirt traps and pre-drilled holes for site fixing. Continuous spring loaded hinges locate into extruded aluminium profiles. Where layout results in an exposed end, a return panel can be supplied in a finish to match the doors.</p>

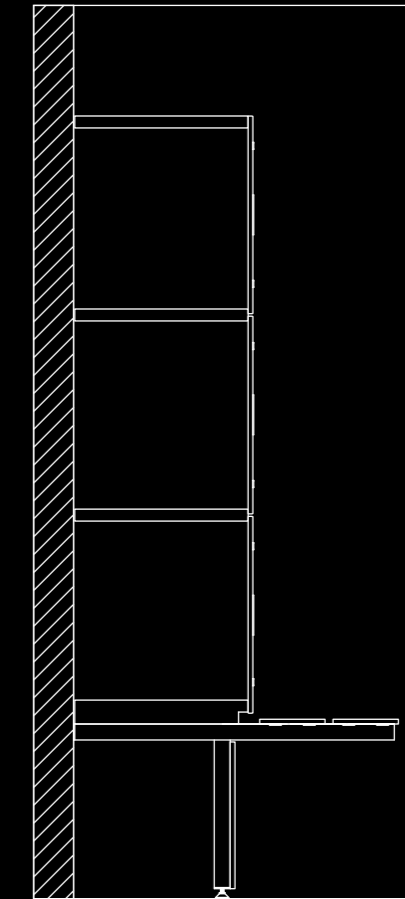
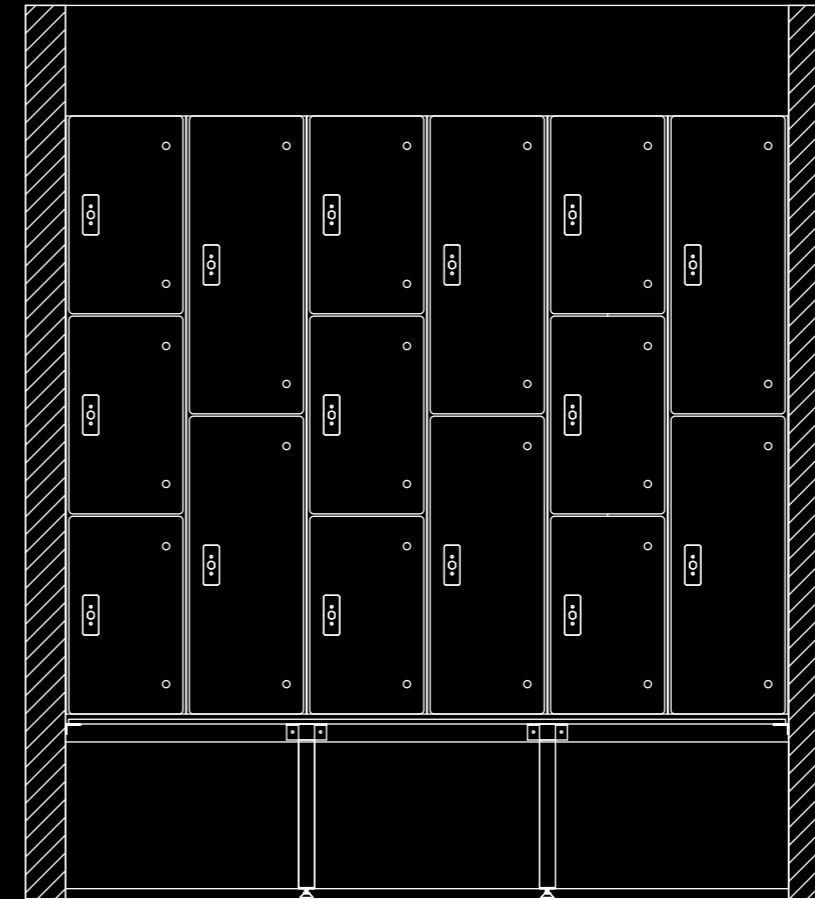
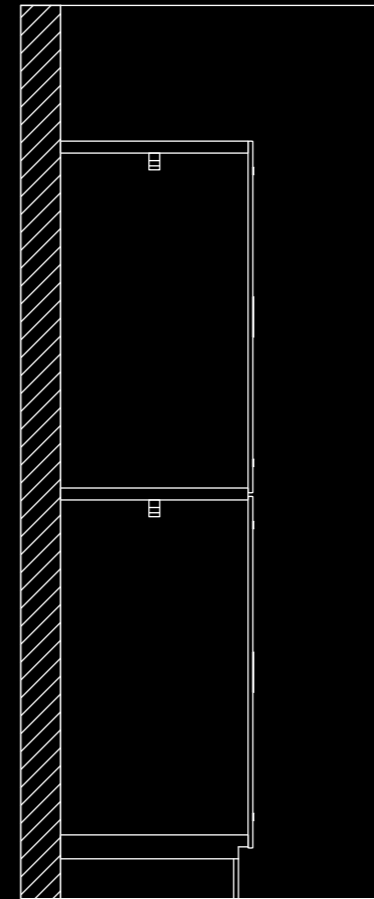
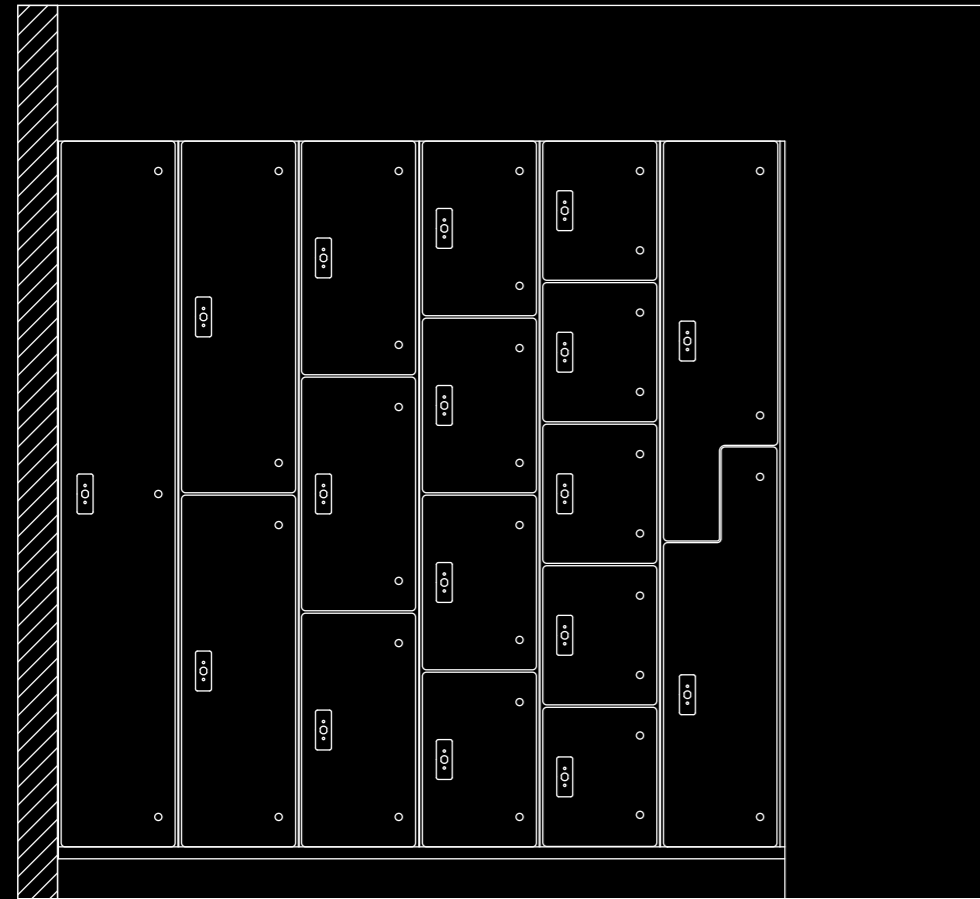
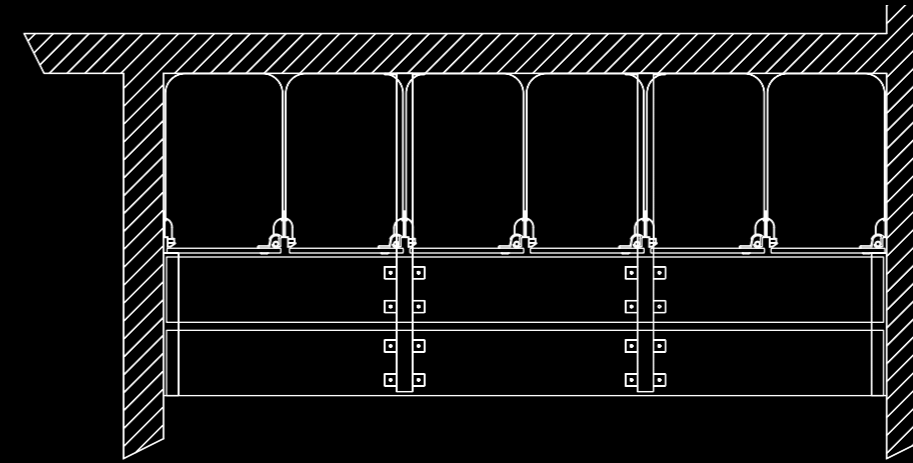
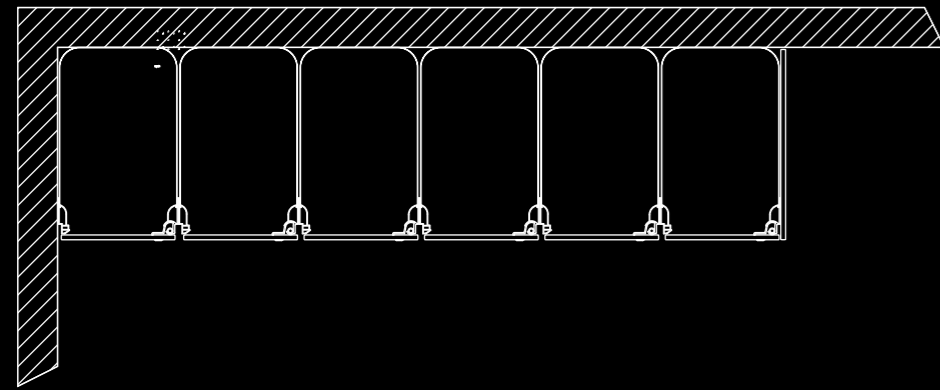

Layout 1

Layout 2

Not to scale



thrislington cubicles

Product: Fusion

Layout: Common details are shown, but the system is designed to be as adaptable as possible, and will fit almost any layout.

Layout 1: Fusion in a corner showing different tier configurations, including z-type.

Layout 2: Fusion lockers and bench between walls, supported on powder coated brackets.

**accessories**

Standard coat hook supplied with each cubicle shown to the right. Others are optional extras.

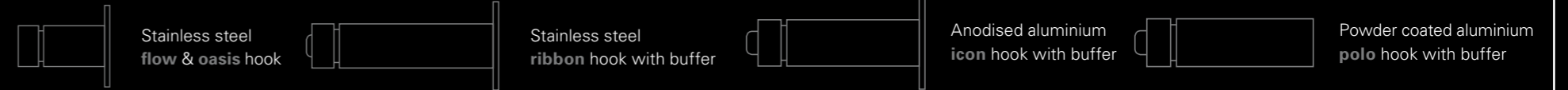

product	features	image	product	features	image
<b>optional coat hooks</b>	<ul style="list-style-type: none"> <li>● High quality stainless steel</li> <li>● Door stop option</li> </ul>	<p>19E1001    19E1002    19E1003    19E1004    19E1005</p>	<b>hand dryers</b>	<ul style="list-style-type: none"> <li>● Five Year Warranty</li> <li>● Auto resetting thermostat</li> <li>● Automatic infra-red sensor</li> <li>● Infra-red automatic</li> <li>● Low energy usage</li> </ul>	<p>19E4001    19E4002    19E4003    19E4004</p>
<b>soap dispensers</b>	<ul style="list-style-type: none"> <li>● High quality stainless steel</li> </ul>	<p>19E2001    19E2002    19E2003    19E2004    19E2005</p>	<b>toilet roll holders</b>	<ul style="list-style-type: none"> <li>● 18/10 nickel stainless steel</li> <li>● Satin or polished finish</li> <li>● Left or right hand assembly</li> </ul>	<p>19E5001    19E5002    19E5003    19E5004</p>
<b>combination units</b>	<ul style="list-style-type: none"> <li>● Five Year Warranty</li> <li>● Auto resetting thermostat</li> <li>● Automatic infra-red sensor</li> <li>● Low energy usage</li> </ul>	<p>19E3001    19E3002    19E3003    19E3004    19E3005</p>	<b>toilet roll dispensers</b>	<ul style="list-style-type: none"> <li>● 18/10 nickel stainless steel</li> <li>● Welded corners - no sharp edges</li> <li>● Inspection slot</li> </ul>	<p>19E6001    19E6002    19E6003    19E6004    19E6005    19E6006</p>
			<b>grab bars</b>	<ul style="list-style-type: none"> <li>● Satin or polished finish</li> <li>● Compliant Doc-M pack</li> </ul>	<p>19E7001    19E7002    19E8001</p>

made in britain.  
used worldwide.



Although all of our products are made and shipped from our base in the UK, we don't just supply the domestic market as we've shipped and installed our cubicles throughout the world in over 30 different countries and 100's of different locations.

Our head office is still in the United Kingdom, but as part of the Strata International Group we now have distributors throughout the world.

Thrislington Head Office  
Prince William Avenue  
Deeside  
CH5 2QZ  
United Kingdom

+44 1244 520677  
sales@thrislingtoncubicles.com  
international@thrislingtoncubicles.com

Thrislington US  
38 Third Ave 100W  
Charlestown Navy Yard  
Boston, MA. 02129  
USA

+1 617 681 6700  
sales@thrislington-us.com

Thrislington Hong Kong  
7/F Yen Sheng Centre  
64 Hoi Yuen Road  
Kwun Tong  
Kowloon  
Hong Kong

+852 2811 5253  
hongkong@thrislingtoncubicles.com

Thrislington Qatar  
Office No. 5  
Ain Khalid Jn.  
Salwa Road  
PO Box 22155  
Doha  
Qatar

+974 4491 6136  
qatar@thrislingtoncubicles.com

Thrislington UAE  
Suite 242  
European Business Centre  
Dubai Investment Park  
PO Box 33635  
Dubai  
UAE

+971 4813 5444  
uae@thrislingtoncubicles.com

Thrislington Nigeria  
Aries Block, Ground Floor,  
Eleganza Plaza,  
Apapa  
Lagos  
Nigeria

+234 8055 449 482  
nigeria@thrislingtoncubicles.com

Thrislington Ireland  
24 Tolka Valley Business Park,  
Ballyboggan Road  
Glasnevin  
Dublin 11  
Ireland

+353 1853 2222  
ireland@thrislingtoncubicles.com

## some of our jobs



Aberdeen University Library  
 Aquatics Centre  
 Assembly Rooms Edinburgh  
 Birmingham Library & REP Theatre  
 Birmingham New Street Station  
 Birmingham Town Hall  
 Bristol Civic Justice Centre  
 Bullring Shopping Centre  
 City of Westminster Courts London  
 Co-operative Group HQ  
 Cutty Sark  
 ExCel  
 Goldman Sachs Peterborough Court  
 John Rylands Library  
 Kings Cross Station  
 Liverpool John Lennon Airport  
 London Eye

London South Bank University  
 Lymington Yacht Haven Marina  
 Manchester Town Hall  
 Museum of Science & Industry  
 Neasden Mandir  
 NEC Birmingham  
 New Museum of Liverpool  
 Olympic Velodrome  
 Oriol Mostyn Gallery  
 Prince of Wales Theatre  
 Rambert Dance Studio  
 Royal Liver Building  
 Sea City Museum  
 Serpentine Sackler Gallery  
 Snowdon Summit Café  
 Somerset House  
 St Georges Park

St Pancras International  
 Wembley London Designer Outlet  
 West Cheshire College Ellesmere Port  
 Westminster Cathedral  
 Bay Atlantic, Lagos  
 British Council, Nairobi  
 Ibis Hotel, Lagos  
 Labadi Beach Hotel, Accra  
 Standard Chartered Bank, Nigeria  
 Yost Grube Hall, Lekki  
 3 Connaught Road, Hong Kong  
 Arcapita Bank, Singapore  
 City Hall, Hong Kong  
 Grand Lisboa Hotel, Macau  
 Housing Authority HQ, Hong Kong  
 Science Park, Hong Kong  
 Apple Store, Amsterdam

Apple Store, Lyon  
 Apple Store, Strasbourg  
 Centrum Cerny Most, Prague  
 Charles de Gaulle Airport, Paris  
 Horizon Serono, Geneva  
 Oslo Opera House  
 Oslo Shopping Centre  
 Silber Palais, Germany  
 University of Oslo  
 ADNEC Feature Tower, Abu Dhabi  
 Arcapita Bank, Manama  
 Doha Convention Centre  
 Princess Nora University  
 Qatar Foundation  
 Queen Alia International Airport  
 World Trade Centre Qatar  
 Barclays Centre New York

Broad Museum, Los Angeles  
 California Memorial Stadium  
 Capital Group, New York  
 Google Project, Washington DC  
 Harvard University, Art Museum  
 Iris - Bill Gates Foundation, Seattle  
 Isabella Stewart Gardner Museum  
 KPF Offices, New York  
 Legal Sea Foods, Boston  
 Lincoln Centre Alice Tully Juilliard  
 MoDA, Georgia  
 Morgan Stanley New York  
 Novartis 230 Park Avenue Project, New York  
 O'Hare Airport, Chicago  
 Skidmore Owings & Merrill, New York  
 Texas Stadium

City Hall, Hong Kong  
 Grand Lisboa Hotel, Macau  
 Housing Authority HQ, Hong Kong  
 Science Park, Hong Kong  
 Apple Store, Amsterdam  
 Apple Store, Lyon  
 Centrum Cerny Most, Prague  
 Charles de Gaulle Airport, Paris  
 Horizon Serono, Geneva  
 Oslo Opera House  
 Oslo Shopping Centre  
 Silber Palais, Germany  
 University of Oslo  
 ADNEC Tower, Abu Dhabi  
 Arcapita Bank, Manama  
 Doha Convention Centre  
 Princess Nora University, Saudi Arabia  
 Qatar Foundation  
 Queen Alia International Airport  
 World Trade Centre, Qatar  
 Barclays Centre New York  
 Broad Museum, Los Angeles  
 California Memorial Stadium  
 Capital Group, New York  
 Darrell K Royal Texas Memorial Stadium  
 Google Project, Washington DC  
 Harvard University Art Museum  
 Iris Bill Gates Foundation, Seattle  
 Isabella Stewart Gardner Museum, Boston  
 KPF Offices, New York  
 Legal Sea Foods, Boston  
 Lincoln Centre  
 Alice Tully Juilliard, New York  
 MoDA, Georgia  
 Morgan Stanley, New York  
 Novartis Park Avenue, New York  
 O'Hare Airport, Chicago  
 Skidmore Owings and Merrill, New York

